

PRODUCT INSPECTION GUIDE



TABLE OF CONTENTS

3 Harness

8 Lanyards

8 Shock Absorbing

11 Rope

15 Web

18 Wire Rope

21 Shock Absorbers

24 Synthetic Rope

24 Twisted Rope

28 Braided Rope

32 Kernmantel Rope

36 Polysteel

40 Wire Rope Lifelines

43 Fall Limiters

43 Retractable Lanyard

55 Self Retracting Lifeline

HARNES INSPECTION GUIDELINES

Webbing

Grasp the webbing with your hands and bend the webbing, checking both sides. This creates surface tension making damaged fibers or cuts easier to see. Webbing damage may not show up through a sight (visual) inspection only – manual (touch) the harness is equally important.

Visual and Touch Inspection	✓ Pass ✗ Fail Criteria
-----------------------------	---------------------------

- ✗ Cuts, nicks or tears
- ✗ Broken fibers/cracks
- ✗ Overall deterioration
- ✗ Modifications by user
- ✗ Fraying/Abrasions
- ✗✓ Discoloration of material Dependant on cause of discoloration
- ✗ Hard or shiny spots Indicates heat damage
- ✗ Webbing thickness uneven Indicates possible fall
- ✓ Mildew Clean harness
- ✗ Missing straps
- ✗ Undue stretching Indicates possible fall
- ✗ Burnt, charred or melted fibers Indicates heat damage
- ✗✓ Material marked w/permanent marker Check w/manufacturer
- ✗ Excessive hardness or brittleness Indicates heat or uv damage

Stitching

- ✗ Pulled stitches
- ✗ Stitching that is missing
- ✗ Hard or shiny spots Indicates heat damage
- ✗ Cut stitches
- ✗✓ Discoloration of stitching Dependant on cause of discoloration

Hardware

- ✗ Distortion (twists, bends)
- ✗ Rough or sharp edges
- ✗ Rust or corrosion
- ✗ Cracks or breaks
- ✗ Broken/distorted grommets
- ✗ Modification by users (ie additional holes)
- ✗ Tongue buckle should overlap the buckle frame and move freely back and forth in their socket
- ✗ Roller of tongue buckle should turn freely on frame
- ✗ Bars must be straight
- ✗ All springs must be in working condition

HARNESSES INSPECTION GUIDELINES

Tagging System

Every harness must have a legible tag identifying the harness, model, date of manufacture, name of manufacturer, limitations and warnings.

- ✘ Check tag for date of manufacture and remove from service if past adopted service life policy.
- ✘ If tagging system is missing or not legible remove harness from service.

Cleaning and Storage

Wipe off all surface dirt with a sponge dampened in plain water. Squeeze the sponge dry. Dip the sponge in a mild solution of water and mild detergent. Work up a thick lather, with a vigorous back and forth motion. Then wipe dry with a clean cloth.

Hang freely to dry, but away from excessive heat, steam or long periods of sunlight.

Storage areas should be clean, dry and free of exposure to fumes, heat, direct ultra violet light, sunlight and corrosive elements.

Note: Do not store harnesses next to batteries, chemical attack can occur if battery leaks.

INSPECTION CHECKLIST - HARNESS

Item Description

1. Dee Ring
2. Dee Pad
3. Nylon Webbing
4. Spring Loaded Friction Buckles
5. Elastic Keepers (2)
6. Nylon Webbing
7. Spring Loaded Friction Buckles
8. Elastic Keepers (2)
9. Nylon Webbing
10. Stitching
11. Stitching
12. Tongue Buckle
13. Elastic Keeper (1)
14. Nylon Webbing
15. Stitching
16. Stitching
17. Tongue Buckle
18. Elastic Keeper (1)
19. Stitching
20. Nylon Webbing
21. Stitching
22. Stitching
23. Nylon Webbing
24. Grommets
25. Stitching
26. Nylon Webbing
27. Stitching
28. Stitching
29. Nylon Webbing
30. Grommets
31. Sub-Pelvic Strap
32. Back Strap
33. Stitching - Back Strap
34. Stitching - Back Strap
35. Chest Strap Pad
36. Nylon Webbing
37. Stitching
38. Mating Link
39. Chest Strap Pad
40. Nylon Webbing
41. Stitching
42. 3 Bar Mating Buckle
43. Elastic Keeper (1)
44. Tagging/Label System

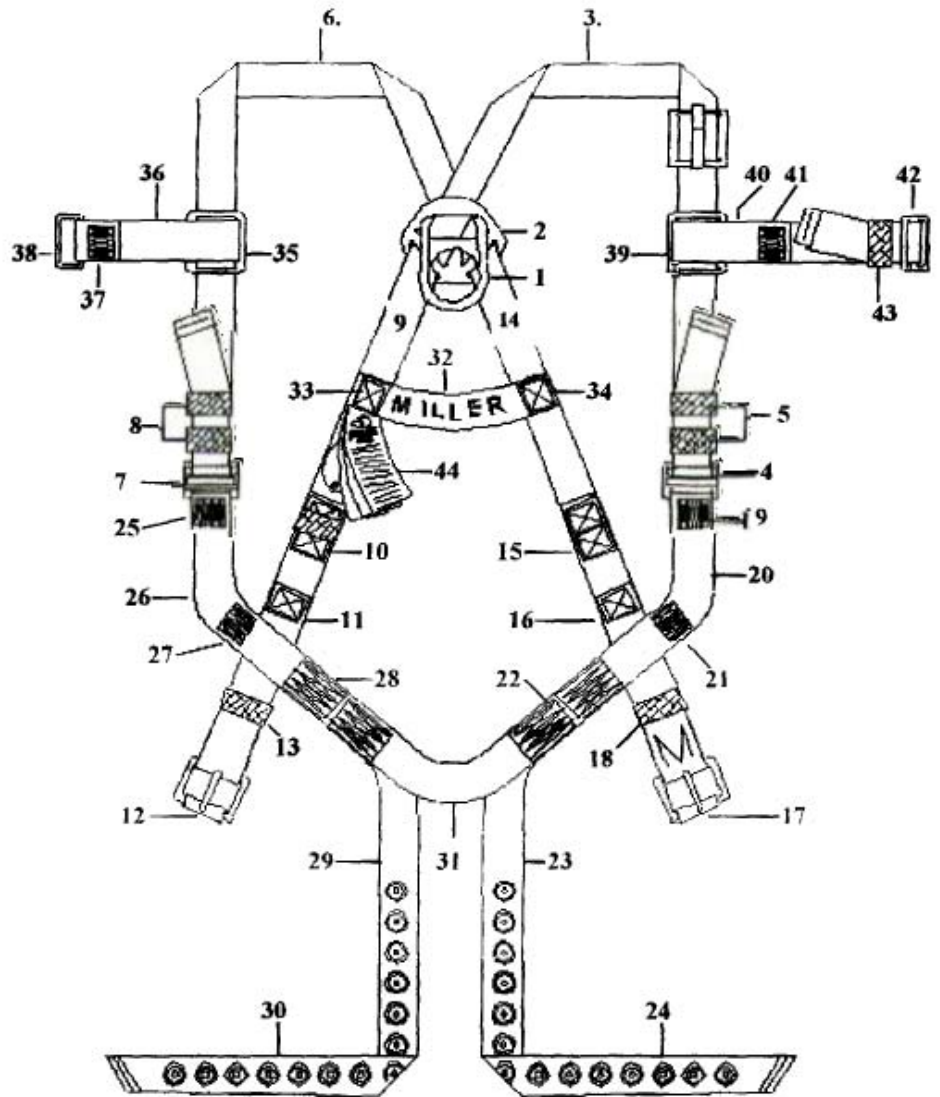

Criteria = FAIL
 = PASS

Serial #:	Date of Manufacture:
Inspector:	Date of Inspection:
Inspector Signature:	
<input checked="" type="checkbox"/> FAIL: <input type="checkbox"/> Initial _____ REMOVE FROM SERVICE	<input checked="" type="checkbox"/> PASS: <input type="checkbox"/> Initial _____ RETURN TO SERVICE

EXAMPLE 1

Some Typical Thread (TH) and Stitch Patterns (SP) in Webbing (W)

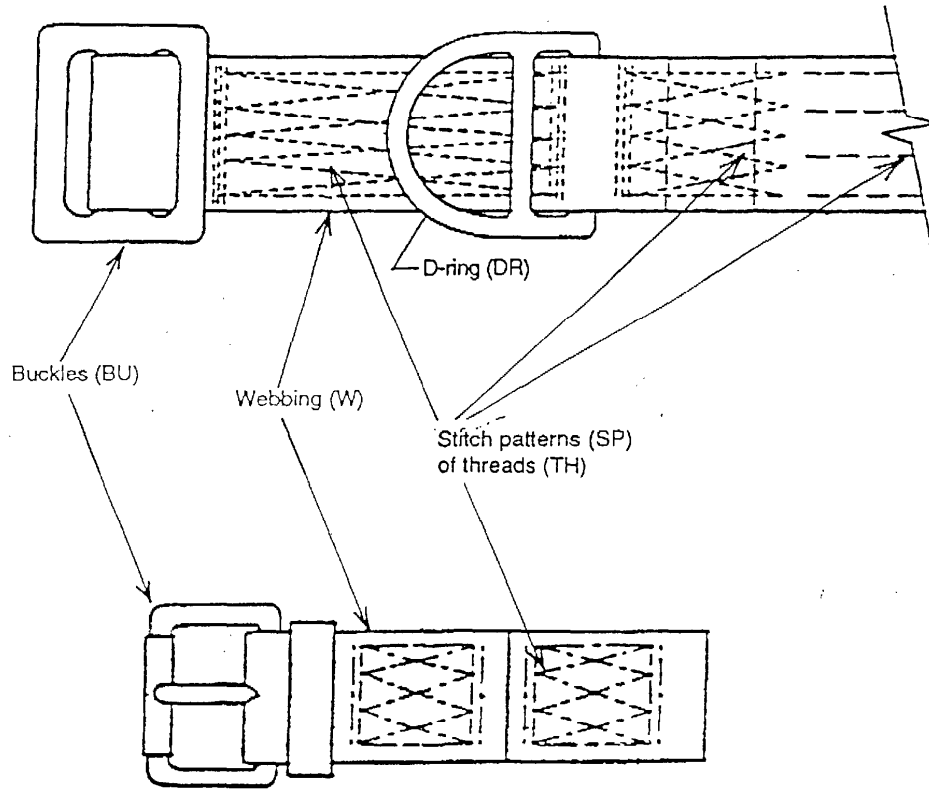

EXAMPLE 2

Some Typical Connector (Hardware) Components and Elements

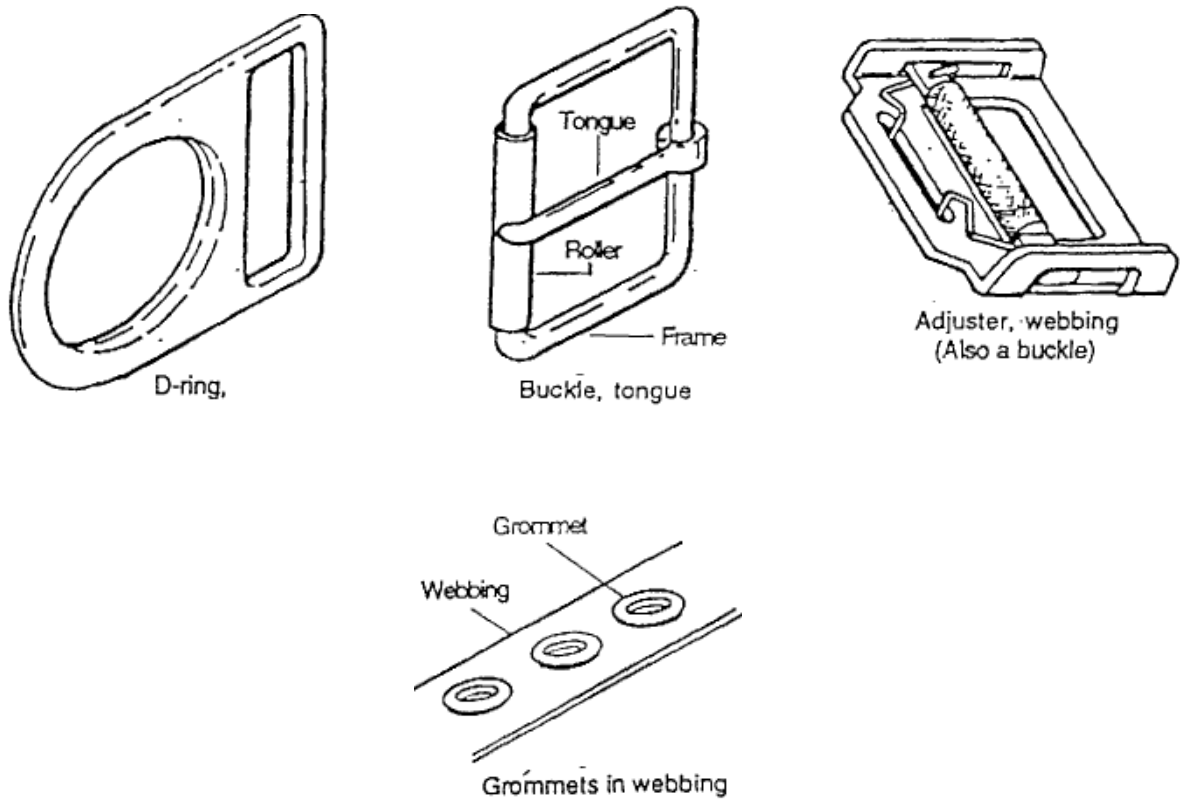

SHOCK ABSORBING LANYARD (MANYARD STYLE) INSPECTION GUIDELINES

Webbing

Grasp the webbing with your hands and bend the webbing, checking both sides.

This creates surface tension making damaged fibers or cuts easier to see. Webbing damage may not show up through a sight (visual) inspection only – manual (touch) the lanyard is equally important. **Pay attention to the wrinkled portion of the lanyard.**

Visual and Touch Inspection	<ul style="list-style-type: none"> ✓ Pass ✗ Fail Criteria
-----------------------------	---

✗ Cuts, nicks or tears	
✗ Broken fibers/cracks	
✗ Overall deterioration	
✗ Modifications by user	
✗ Fraying/Abrasions	
✗✓ Discoloration of material	Dependant on cause of discoloration
✗ Hard or shiny spots	Indicates heat damage
✗ Change in core size	Indicates possible fall
✓ Mildew	Clean lanyard
✗ Missing or popped flag	Indicates possible fall
✗ Undue stretching	Indicates possible fall
✗ Burnt, charred or melted fibers	Indicates heat damage
✗✓ Material marked w/permanent marker	Check w/manufacturer
✗ Excessive hardness or brittleness	Indicates heat or UV damage
✗ Knots in lanyard	

Stitching

✗ Pulled stitches	
✗ Stitching that is missing	
✗ Hard or shiny spots	Indicates heat damage
✗ Cut stitches	
✗✓ Discoloration of stitching	Dependant on cause of discoloration

SHOCK ABSORBING LANYARD (MANYARD STYLE) INSPECTION GUIDELINES

Snap Hooks

Snap hooks should be of the self-locking type. Snap hooks are generally proof tested to 3,600 lbs and have minimum tensile strength of 5,000 lbs.

Visual and Touch Inspection	✓ Pass ✗ Fail Criteria
-----------------------------	---------------------------

- ✗ Snap hooks should be of the self-locking type
- ✗ No hook or eye distortion (twists, bends, or elongation)
- ✗ Latch/keeper should seat into the nose w/o binding
- ✗ Latch/keeper should not be distorted or obstructed
- ✗ Overall deterioration/Excessive wear
- ✗ Modifications by the user
- ✗ Rust/pitting/corrosion
- ✗ No cracks
- ✗ No missing parts
- ✗ No excessive wear
- ✗ No rough or sharp edges

Snap Hook Locking Mechanism

- ✗ Disengage locking mechanism and open keeper (keeper should open freely)
- ✗ Disengage locking mechanism and release (locking mechanism should return to engaged position)

Snap Hook Keeper

- ✗ Check keeper spring action by opening the keeper and releasing (keeper should return to closed position without hanging up it should not close slowly)
- ✗ Push on keeper without engaging locking mechanism (keeper should not open)
- ✗ Check to see the keeper is seated firmly on the snap hook nose – there should be no side play (lateral movement)

Tagging System

Every lanyard must have a legible tag identifying the lanyard, model, date of manufacture, name of manufacturer, limitations and warnings.

- ✗ Check tag for date of manufacture and remove from service if past adopted service life policy
- ✗ If tagging system is missing remove lanyard from service.

Cleaning and Storage

Wipe off all surface dirt with a sponge dampened in plain water. Squeeze the sponge dry. Dip the sponge in a mild solution of water and mild detergent. Work up a thick lather, with a vigorous back and forth motion. Then wipe dry with a clean cloth.

Hang freely to dry, but away from excessive heat, steam, or long periods of sunlight.

Storage areas should be clean, dry and free of exposure to fumes, heat, direct ultra violet light, sunlight, and corrosive elements.

Note: Do not store lanyards next to batteries, chemical attack on the lanyard can occur if battery leaks.

Notes
<hr/> <hr/> <hr/> <hr/> <hr/> <hr/> <hr/> <hr/> <hr/> <hr/>

INSPECTION CHECKLIST - FALL PROTECTION EQUIPMENT

Description:	Model #:
Serial #:	Date of Manufacture:
Inspector:	Date Inspected:
Inspector Signature:	

X FAIL: Initial _____
REMOVE FROM SERVICE

✓ PASS: Initial _____
RETURN TO SERVICE

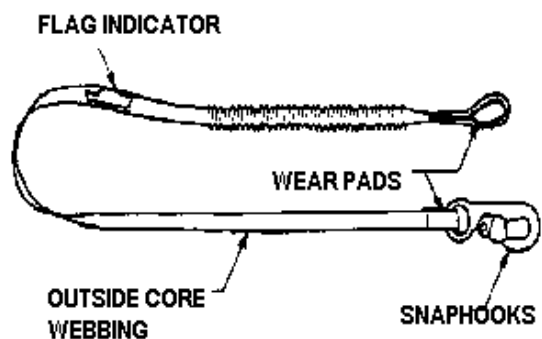

Style A

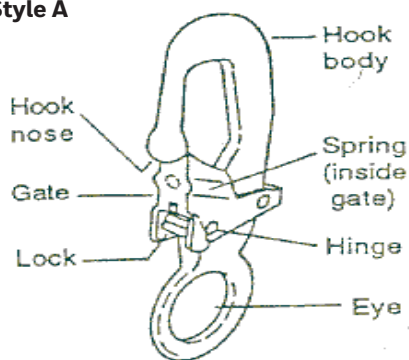

Snaphook, Self-locking

Style B

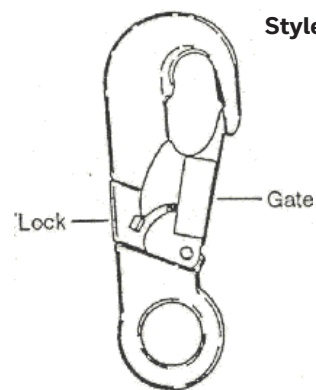

Snaphook, Self-locking

Item #	Description	Fail X	Pass ✓	Comments
	LANYARD			
	Flag Indicator			
	Outside Core Webbing			
	Core			
	Stitching			
	Labeling (tags)			
	Wear Pads			
	SNAPHOOK			
	Hook Body			
	Hook Nose			
	Gate (keeper)			
	Lock			
	Eye			
	Hinge			
	Spring (inside gate)			

ROPE LANYARDS (SYNTHETIC) INSPECTION GUIDELINES

Rope

Grasp the rope with both hands and rotate the lanyard. Inspect strands from end to end. Remember to check inner strands for signs of damage, deterioration, or chemical attack.

Synthetic fiber ropes will show a reduction in strength when used at elevated temperatures. For exposure to excessive temperatures specific for the rope fiber refer to the rope manufacturer's specifications and instructions.

Damage and deterioration may not show up through a sight (visual) inspection only – manual (touch) the lanyard is equally important.

Rope Diameter

Weakened areas from extreme loads will appear as a noticeable change in original diameter. The rope diameter should be uniform throughout. If areas appear to be reduced more than 5% from original rope diameter, remove from service (ie: 5/8" rope, 5% reduction would be approx. 1/32" – calipers can be used to measure.)

Visual and Touch Inspection	<ul style="list-style-type: none"> ✓ Pass ✗ Fail Criteria
-----------------------------	---

✗ Fiber, cuts, or nicks	
✗ Broken fibers	
✗ Fuzzy or worn fibers	
✗ Overall deterioration	
✗ Modifications by user	
✗ Fraying/Abrasions	
✗ Hard or shiny spots	Indicates heat damage
✗ Fused fibers or strands	Indicates heat damage
✗ Change in original diameter	Indicates possible fall
✗ Burnt, charred, or melted fibers	Indicates heat damage
✗✓ Material marked w/permanent marker	Check w/manufacturer
✗ Excessive hardness or brittleness	Indicates heat or uv damage
✗ Kinks, hockling*, or knots	
✗✓ Discoloration of rope and brittle fibers (such as splinters/slivers)	Dependant on cause of discoloration but may indicate chemical attack or UV degradation

* **HOCKLING** – unraveling of the lanyard due to constant turning in the same direction or shock loading

ROPE LANYARDS (SYNTHETIC) INSPECTION GUIDELINES

Thimbles and Eyes

Thimbles (steel or plastic) must be seated firmly in the eye. Thimbles must not show any sign of damage. Check around the eye itself for damage, wear or deterioration.

Visual and Touch Inspection

- ✓ Pass
- ✗ Fail Criteria

- ✗ Missing thimble(s)
- ✗ Loose thimble(s)
- ✗ Damaged thimbles - white stress marks, thimble collapsing over itself
- ✗ Eye damage due to cuts, nicks, abrasions, fraying, fused areas (look for same indicators as you would for the rope body itself)
- ✗ Eyes with metal thimbles – look for rust in or around the eye

Rope Splices

In the construction of the lanyard the rope is spliced around a plastic or metal thimble. Eye splices in twisted rope having three or more strands shall have a minimum of four tucks (ANSI Z359.1-1992.) (CSA-Z259.1-95 requires a minimum of five full tucks.) Both standards require the ends secured to prevent unraveling.

- ✗ Splices not secured properly from unraveling – look for tape, shrink wrap tube, stiffening agent (most common methods used by manufacturers)
- ✗ Splices starting to unravel
- ✗ Splices showing damage or deterioration (look for same indicators as you would for the rope itself)

ROPE LANYARDS (SYNTHETIC) INSPECTION GUIDELINES

Snap Hooks

Snap hooks should be of the self-locking type. Snap hooks are generally proof tested to 3,600 lbs and have minimum tensile strength of 5,000 lbs.

Visual and Touch Inspection

- ✓ Pass
- ✗ Fail Criteria

- ✗ Snap hooks should be of the self-locking type
- ✗ No hook or eye distortion (twists, bends, or elongation)
- ✗ Latch/keeper should seat into the nose w/o binding
- ✗ Latch/keeper should not be distorted or obstructed
- ✗ Overall deterioration/Excessive wear
- ✗ Modifications by the user
- ✗ Rust/pitting/corrosion
- ✗ No cracks
- ✗ No missing parts
- ✗ No excessive wear
- ✗ No rough or sharp edges

Snap Hook Locking Mechanism

- ✗ Disengage locking mechanism and open keeper (keeper should open freely)
- ✗ Disengage locking mechanism and release (locking mechanism should return to engaged position).

Snap Hook Keeper

- ✗ Check keeper spring action by opening the keeper and releasing (keeper should return to closed position without hanging up it should not close slowly)
- ✗ Push on keeper without engaging locking mechanism (keeper should not open)
- ✗ Check to see the keeper is seated firmly on the snap hook nose – there should be no side play (lateral movement)

Tagging System

Every lanyard must have a legible tag identifying the lanyard, model, date of manufacture, name of manufacturer, limitations, and warnings.

- ✗ Check tag for date of manufacture and remove from service if past adopted service life policy
- ✗ If tagging system is missing or not legible remove lanyard from service.

Cleaning and Storage

Wipe off all surface dirt with a sponge dampened in plain water. Squeeze the sponge dry. Dip the sponge in a mild solution of water and mild detergent. Work up a thick lather, with a vigorous back and forth motion. Then wipe dry with a clean cloth.

Hang freely to dry, but away from excessive heat, steam, or long periods of sunlight.

Storage areas should be clean, dry and free of exposure to fumes, heat, direct ultra violet light, sunlight, and corrosive elements. Lanyards should be kept off the floor to provide ventilation underneath. Never store directly on a concrete or dirt floor.

Note: Do not store lanyards next to batteries, chemical attack on the lanyard can occur if battery leaks.

INSPECTION CHECKLIST - FALL PROTECTION EQUIPMENT

Description:	Model #:
Serial #:	Date of Manufacture:
Inspector:	Date Inspected:
Inspector Signature:	

X FAIL: Initial _____

✓ PASS: Initial _____

REMOVE FROM SERVICE

RETURN TO SERVICE

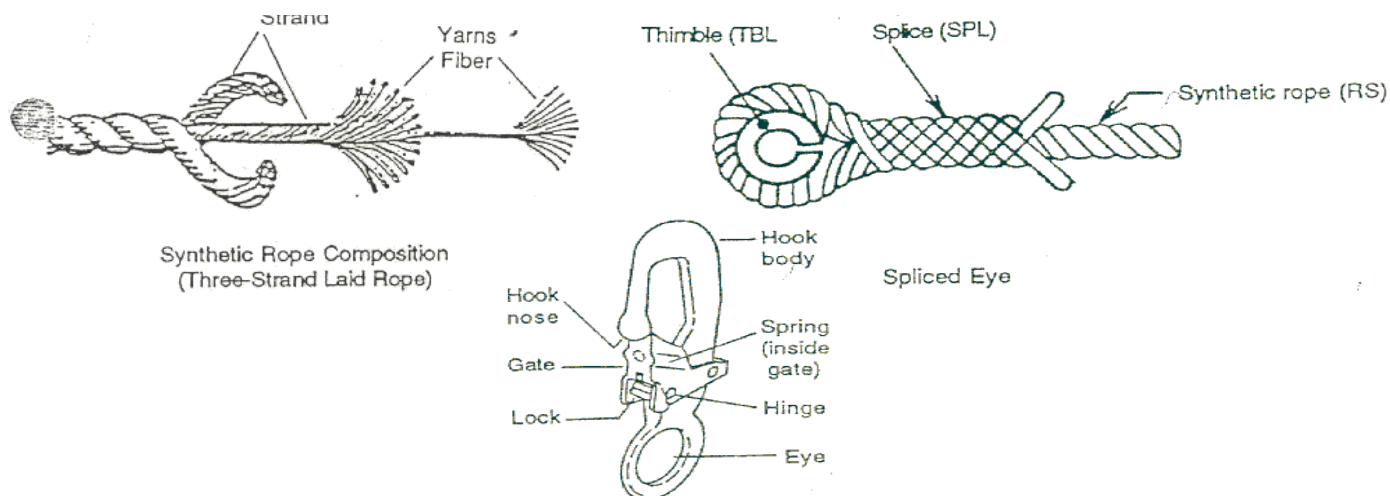

Item #	Description	Fail X	Pass ✓	Comments
	LANYARD			
	Rope Fibers			
	Rope Splices			
	Thimbles and Eyes			
	Rope Diameter			
	Labeling (tags)			
	Rope Hockling			
	SNAPHOOK			
	Hook Body			
	Hook Nose			
	Gate (keeper)			
	Lock			
	Eye			
	Hinge			
	Spring (inside gate)			

WEB LANYARDS INSPECTION GUIDELINES

Webbing

Grasp the webbing with your hands and bend the webbing, checking both sides. This creates surface tension making damaged fibers or cuts easier to see. Webbing damage may not show up through a sight (visual) inspection only – manual (touch) inspection of the lanyard is equally important.

Visual and Touch Inspection	<ul style="list-style-type: none"> ✓ Pass ✗ Fail Criteria
-----------------------------	---

- | | |
|---------------------------------------|-------------------------------------|
| ✗ Cuts, nicks, or tears | |
| ✗ Broken fibers/cracks | |
| ✗ Overall deterioration | |
| ✗ Modifications by user | |
| ✗ Fraying/Abrasions | |
| ✗✓ Discoloration of material | Dependant on cause of discoloration |
| ✗ Hard or shiny spots | Indicates heat damage |
| ✗ Change in core size | Indicates possible fall |
| ✓ Mildew | Clean lanyard |
| ✗ Undue stitching | Indicates possible fall |
| ✗ Burnt, charred, or melted fibers | Indicates heat damage |
| ✗✓ Material marked w/permanent marker | Check w/manufacturer |
| ✗ Excessive hardness or brittleness | Indicates heat or UV damage |
| ✗ Knots in lanyard | |

Stitching

- | | |
|-------------------------------|-------------------------------------|
| ✗ Pulled stitches | |
| ✗ Stitching that is missing | |
| ✗ Hard or shiny spots | Indicates heat damage |
| ✗ Cut stitches | |
| ✗✓ Discoloration of stitching | Dependant on cause of discoloration |

WEB LANYARDS INSPECTION GUIDELINES

Snap Hooks

Snap hooks should be of the self-locking type. Snap hooks are generally proof tested to 3,600 lbs and have minimum tensile strength of 5,000 lbs.

Visual and Touch Inspection

- ✓ Pass
- ✗ Fail Criteria

- ✗ Snap hooks should be of the self-locking type
- ✗ No hook or eye distortion (twists, bends, or elongation)
- ✗ Latch/keeper should seat into the nose w/o binding
- ✗ Latch/keeper should not be distorted or obstructed
- ✗ Overall deterioration/Excessive wear
- ✗ Modifications by the user
- ✗ Rust/pitting/corrosion
- ✗ No cracks
- ✗ No missing parts
- ✗ No excessive wear
- ✗ No rough or sharp edges

Snap Hook Locking Mechanism

- ✗ Disengage locking mechanism and open keeper (keeper should open freely)
- ✗ Disengage locking mechanism and release (locking mechanism should return to engaged position).

Snap Hook Keeper

- ✗ Check keeper spring action by opening the keeper and releasing (keeper should return to closed position without hanging up it should not close slowly)
- ✗ Push on keeper without engaging locking mechanism (keeper should not open)
- ✗ Check to see the keeper is seated firmly on the snap hook nose – there should be no side play (lateral movement)

Tagging System

Every lanyard must have a legible tag identifying the lanyard, model, date of manufacture, name of manufacturer, limitations, and warnings.

- ✗ Check tag for date of manufacture and remove from service if past adopted service life policy
- ✗ If tagging system is missing or not legible remove lanyard from service

Cleaning and Storage

Wipe off all surface dirt with a sponge dampened in plain water. Squeeze the sponge dry. Dip the sponge in a mild solution of water and mild detergent. Work up a thick lather, with a vigorous back and forth motion. Then wipe dry with a clean cloth.

Hang freely to dry, but away from excessive heat, steam, or long periods of sunlight. Lanyards must be dry before storage.

Storage areas should be clean, dry, and free of exposure to fumes, heat, direct ultra violet light, sunlight, and corrosive elements.

Note: Do not store lanyards next to batteries, chemical attack on the lanyard can occur if battery leaks.

INSPECTION CHECKLIST - FALL PROTECTION EQUIPMENT

Description:	Model #:
Serial #:	Date of Manufacture:
Inspector:	Date Inspected:
Inspector Signature:	

X FAIL: Initial _____
REMOVE FROM SERVICE

✓ PASS: Initial _____
RETURN TO SERVICE

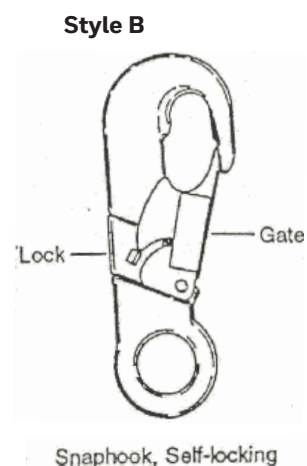
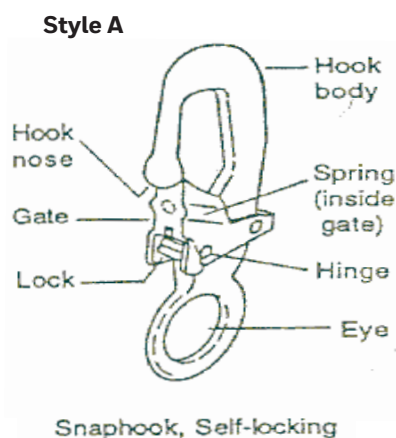
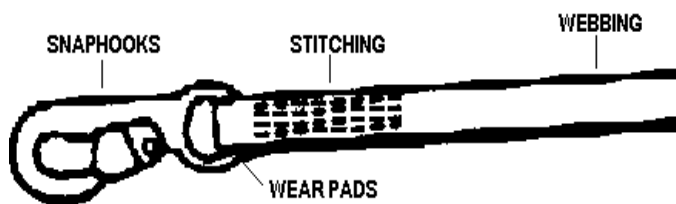

Item #	Description	Fail X	Pass ✓	Comments
	LANYARD			
	Webbing			
	Stitching			
	Wear Pads			
	Labeling (tags)			
	SNAPHOOK			
	Hook Body			
	Hook Nose			
	Gate (keeper)			
	Lock			
	Eye			
	Hinge			
	Spring (inside gate)			

WIRE ROPE LANYARDS

INSPECTION GUIDELINES

Wire Rope

Grasp the steel lanyard with your hands and rotate the lanyard, checking both sides. Watch for unusual wearing patterns on the wire. Broken strands or wires will separate from the body of the lanyard. **To avoid hand injury always wear protective gloves when inspecting a wire rope lanyard.**

Note: Unlike rigging inspection standards, wire rope used for the purpose of fall protection does not allow any broken wires or strands.

Visual and Touch Inspection

- ✓ Pass
- ✗ Fail Criteria

- ✗ Cuts, frayed areas
- ✗ Worn or broken strands/wires
- ✗ Overall deterioration/Excessive outside wear
- ✗ Modifications by user
- ✗ Rust/pitting/corrosion
- ✗ Crushed/jammed or flattened strands
- ✗ Bulges in rope
- ✗ Gaps between strands
- ✗ Heat damage, torch burns, or electric arc strikes
- ✗ Kinks, bird-caging
- ✗ Core protrusion
- ✗ Do not use frozen rope

Fittings

- ✗ Wear or cracks
- ✗ Corrosion or pitting
- ✗ Deformation/bends
- ✗ Mismatched parts or modification
- ✗ Obvious damage

Splices

- ✗ Worn or broken wires
- ✗ Crushed/jammed or flattened strands
- ✗ Corrosion

WIRE ROPE LANYARDS

INSPECTION GUIDELINES

Snap Hooks

Snap hooks should be of the self-locking type. Snap hooks are generally proof tested to 3,600 lbs and have minimum tensile strength of 5,000 lbs.

Visual and Touch Inspection

- ✓ Pass
- ✗ Fail Criteria

- ✗ Snap hooks should be of the self-locking type
- ✗ No hook or eye distortion (twists, bends, or elongation)
- ✗ Latch/keeper should seat into the nose w/o binding
- ✗ Latch/keeper should not be distorted or obstructed
- ✗ Overall deterioration/Excessive wear
- ✗ Modifications by the user
- ✗ Rust/pitting/corrosion
- ✗ No cracks
- ✗ No missing parts
- ✗ No excessive wear
- ✗ No rough or sharp edges

Snap Hook Locking Mechanism

- ✗ Disengage locking mechanism and open keeper (keeper should open freely)
- ✗ Disengage locking mechanism and release (locking mechanism should return to engaged position)

Snap Hook Keeper

- ✗ Check keeper spring action by opening the keeper and releasing (keeper should return to closed position without hanging up it should not close slowly)
- ✗ Push on keeper without engaging locking mechanism (keeper should not open)
- ✗ Check to see the keeper is seated firmly on the snap hook nose – there should be no side play (lateral movement)

Tagging System

Every lanyard must have a legible tag identifying the lanyard, model, date of manufacture, name of manufacturer, limitations, and warnings.

- ✗ Check tag for date of manufacture and remove from service if past adopted service life policy
- ✗ If tagging system is missing or not legible remove lanyard from service.

Cleaning and Storage

Wipe off all surface dirt, dust, and extra oils with a dry cloth.

Storage areas should be clean, dry, and free of exposure to contaminants or corrosive elements.

INSPECTION CHECKLIST - FALL PROTECTION EQUIPMENT

Description:	Model #:
Serial #:	Date of Manufacture:
Inspector:	Date Inspected:
Inspector Signature:	

X FAIL: Initial _____ **✓ PASS:** Initial _____
REMOVE FROM SERVICE **RETURN TO SERVICE**

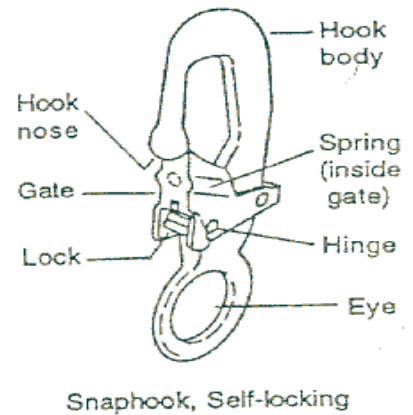
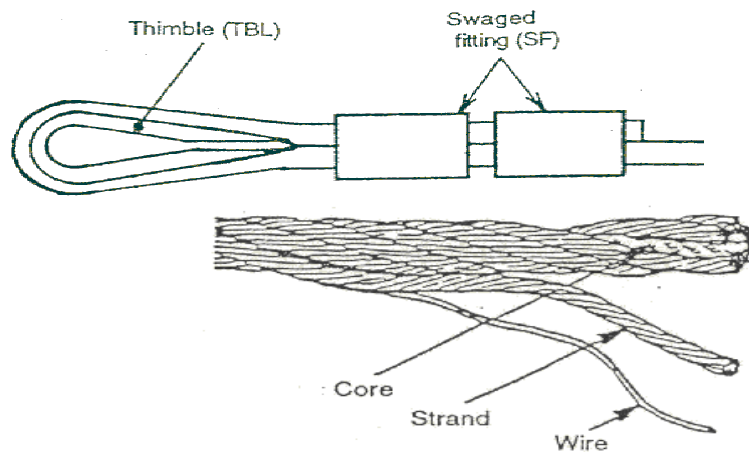

Item #	Description	Fail X	Pass ✓	Comments
	LANYARD			
	Broken Wires			
	Rust/Corrosion/Pitting			
	Deformations			
	Heat Damage			
	Fittings/Thimbles			
	Splices			
	Labeling (tags)			
	SNAPHOOK			
	Hook Body			
	Hook Nose			
	Gate (keeper)			
	Lock			
	Eye			
	Hinge			
	Spring (inside gate)			

SHOCK ABSORBERS - POUCH STYLE INSPECTION GUIDELINES

Shock Absorbers – Pouch Style

Examine the outer portion of the pack.

Visual and Touch Inspection

- ✓ Pass
- ✗ Fail Criteria

- ✗ Burn holes
- ✗ Tears/cuts
- ✗ Modifications by user
- ✗ Chemical attack
- ✗ Obvious signs of deterioration

Stitching

- ✗ Pulled stitches
- ✗ Stitching that is missing
- ✗ Hard or shiny spots Indicates heat damage
- ✗ Cut stitches
- ✗✓ Discoloration of stitching Dependant on cause of discoloration
- ✗ Obvious signs of deterioration

End Loops

- ✗ Cuts or frays
 - ✗ Obvious signs of deterioration
- (There should be no damage to the end loops)

SHOCK ABSORBERS - POUCH STYLE INSPECTION GUIDELINES

Snap Hooks

Snap hooks should be of the self-locking type. Snap hooks are generally proof tested to 3,600 lbs and have minimum tensile strength of 5,000 lbs.

Visual and Touch Inspection

- ✓ Pass
- ✗ Fail Criteria

- ✗ Snap hooks should be of the self-locking type
- ✗ No hook or eye distortion (twists, bends, or elongation)
- ✗ Latch/keeper should seat into the nose w/o binding
- ✗ Latch/keeper should not be distorted or obstructed
- ✗ Overall deterioration/Excessive wear
- ✗ Modifications by the user
- ✗ Rust/pitting/corrosion
- ✗ No cracks
- ✗ No missing parts
- ✗ No excessive wear
- ✗ No rough or sharp edges

Snap Hook Locking Mechanism

- ✗ Disengage locking mechanism and open keeper (keeper should open freely)
- ✗ Disengage locking mechanism and release (locking mechanism should return to engaged position)

Snap Hook Keeper

- ✗ Check keeper spring action by opening the keeper and releasing (keeper should return to closed position without hanging up it should not close slowly)
- ✗ Push on keeper without engaging locking mechanism (keeper should not open)
- ✗ Check to see the keeper is seated firmly on the snap hook nose – there should be no side play (lateral movement)

Tagging System

Every pouch must have a legible tag identifying the pouch, model, date of manufacture, name of manufacturer, limitations, and warnings.

- ✗ Check tag for date of manufacture and remove from service if past adopted service life policy
- ✗ If tagging system is missing or not legible remove lanyard from service.

Cleaning and Storage

Wipe off all surface dirt with a sponge dampened in plain water. Squeeze the sponge dry. Then wipe away any excess moisture with a dry clean cloth.

Dry away from excessive heat, steam, or long periods of sunlight. Pouch must be dry before storage.

Storage areas should be clean, dry, and free of exposure to fumes, heat, direct ultra violet light, sunlight, and corrosive elements.

Note: Do not store pouch next to batteries, chemical attack on the lanyard can occur if battery leaks.

INSPECTION CHECKLIST - FALL PROTECTION EQUIPMENT

Description:	Model #:
Serial #:	Date of Manufacture:
Inspector:	Date Inspected:
Inspector Signature:	

X FAIL: Initial _____
REMOVE FROM SERVICE

✓ PASS: Initial _____
RETURN TO SERVICE

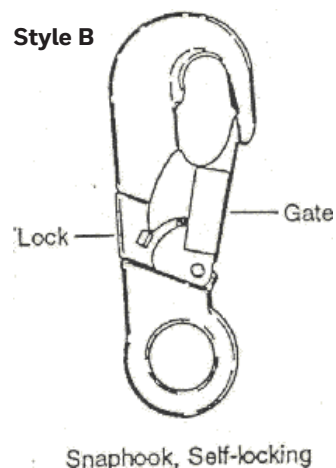
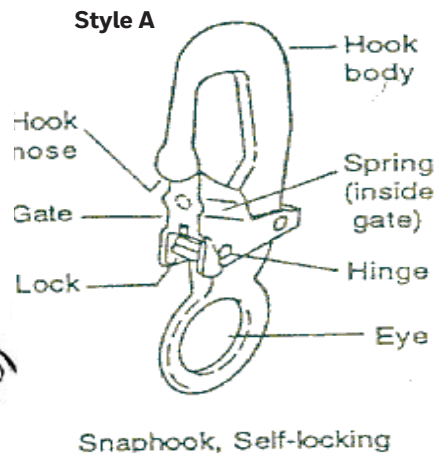
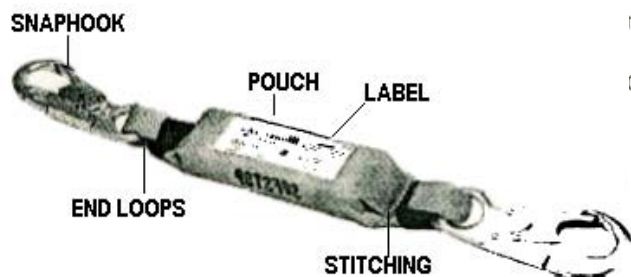

Item #	Description	Fail X	Pass ✓	Comments
	LANYARD			
	Pouch Damage			
	Stitching			
	End Loops			
	Labeling (tags)			
	SNAPHOOK			
	Hook Body			
	Hook Nose			
	Gate (keeper)			
	Lock			
	Eye			
	Hinge			
	Spring (inside gate)			

SYNTHETIC ROPE - LIFELINES - TWISTED ROPES INSPECTION GUIDELINES

Twisted Ropes

Grasp the rope with both hands and rotate the lifeline. Inspect strands from end to end. Remember to check inner strands for signs of damage, deterioration, or chemical attack.

Synthetic fiber ropes will show a reduction in strength when used at elevated temperatures. For exposure to excessive temperatures specific for the rope fiber refer to the rope manufacturer's specifications and instructions.

Damage and deterioration may not show up through a sight (visual) inspection only – manual (touch) the lanyard is equally important.

Rope Diameter

Weakened areas from extreme loads will appear as a noticeable change in original diameter. The rope diameter should be uniform throughout. If areas appear to be reduced more than 5% from original rope diameter, remove from service (ie: 5/8" rope, 5% reduction would be approx. 1/32" – calipers can be used to measure.)

Visual and Touch Inspection	✓ Pass	✗ Fail Criteria
✗ Fiber, cuts, or nicks		
✗ Broken fibers		
✗ Fuzzy or worn fibers		
✗ Overall deterioration		
✗ Modifications by user		
✗ Fraying/Abrasions		
✗ Hard or shiny spots		Indicates heat damage
✗ Fused fibers or strands		Indicates heat damage
✗ Change in original diameter		Indicates possible fall
✗ Burnt, charred, or melted fibers		Indicates heat damage
✗✓ Material marked w/permanent marker		Check w/manufacturer
✗ Kinks, hockling,* or knots		
✗✓ Discoloration of rope and brittle fibers (such as splinters/slivers)		Dependant on cause of discoloration but may indicate chemical attack or UV degradation

* **HOCKLING** – unraveling of the lanyard due to constant turning in the same direction or shock loading

SYNTHETIC ROPE - LIFELINES - TWISTED ROPES INSPECTION GUIDELINES

Thimbles and Eyes

Thimbles (steel or plastic) must be seated firmly in the eye. Thimbles must not show any sign of damage. Check around the eye itself for damage, wear, or deterioration.

Visual and Touch Inspection

- ✓ Pass
- ✗ Fail Criteria

- ✗ Missing thimble(s)
- ✗ Loose thimble(s)
- ✗ Damaged thimble - white stress marks, thimble collapsing over itself
- ✗ Eye damage due to cuts, nicks, abrasions, fraying, fused areas (look for same indicators as you would for the rope body itself)
- ✗ Eyes with metal thimbles – look for rust in or around the eye

Rope Splices

In the construction of the lifeline the rope is spliced around a plastic or metal thimble. Eye splices in twisted rope having three or more strands shall have a minimum of four tucks (ANSI Z359.1-1992.) (CSA-Z259.1-95 requires a minimum of five full tucks.) Both standards require the ends secured to prevent unraveling.

- ✗ Splices not secured properly from unraveling – look for tape, shrink wrap tube, stiffening agent (most common methods used by manufacturers)
- ✗ Splices starting to unravel
- ✗ Splices showing damage or deterioration (look for same indicators as you would for the rope itself)

SYNTHETIC ROPE - LIFELINES - TWISTED ROPES INSPECTION GUIDELINES

Snap Hooks

Snap hooks should be of the self-locking type. Snap hooks are generally proof tested to 3,600 lbs and have minimum tensile strength of 5,000 lbs.

Visual and Touch Inspection

- ✓ Pass
- ✗ Fail Criteria

- ✗ Snap hooks should be of the self-locking type
- ✗ No hook or eye distortion (twists, bends, or elongation)
- ✗ Latch/keeper should seat into the nose w/o binding
- ✗ Latch/keeper should not be distorted or obstructed
- ✗ Overall deterioration/Excessive wear
- ✗ Modifications by the user
- ✗ Rust/pitting/corrosion
- ✗ No cracks
- ✗ No missing parts
- ✗ No excessive wear
- ✗ No rough or sharp edges

Snap Hook Locking Mechanism

- ✗ Disengage locking mechanism and open keeper (keeper should open freely)
- ✗ Disengage locking mechanism and release (locking mechanism should return to engaged position)

Snap Hook Keeper

- ✗ Check keeper spring action by opening the keeper and releasing (keeper should return to closed position without hanging up it should not close slowly)
- ✗ Push on keeper without engaging locking mechanism (keeper should not open)
- ✗ Check to see the keeper is seated firmly on the snap hook nose – there should be no side play (lateral movement)

Tagging System

Lifelines must have a legible tag identifying the, model, date of manufacture, name of manufacturer, limitations, and warnings.

- ✗ Check tag for date of manufacture and remove from service if past adopted service life policy
- ✗ If tagging system is missing or not legible remove lanyard from service.

Cleaning and Storage

Rope can be washed to remove dirt or abrasive particles. Use a solution of mild detergent and cold water. (Note that washing can remove any coatings that may have been added to enhance the performance of the product.)

Hang freely to dry, but away from excessive heat, steam, or long periods of sunlight. Lifelines must be dry before storage.

Storage areas should be clean, dry and free of exposure to fumes, heat, direct ultra violet light, sunlight, and corrosive elements. Lifelines should be kept off the floor to provide ventilation underneath. Never store directly on a concrete or dirt floor.

Note: Do not store lifelines next to batteries, chemical attack on the lifeline can occurs if battery leaks.

INSPECTION CHECKLIST - FALL PROTECTION EQUIPMENT

Description:	Model #:
Serial #:	Date of Manufacture:
Inspector:	Date Inspected:
Inspector Signature:	

X FAIL: Initial _____

✓ PASS: Initial _____

REMOVE FROM SERVICE

RETURN TO SERVICE

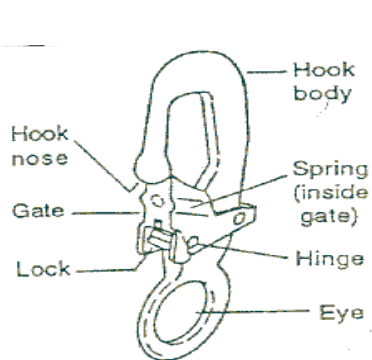

Snaphook, Self-locking

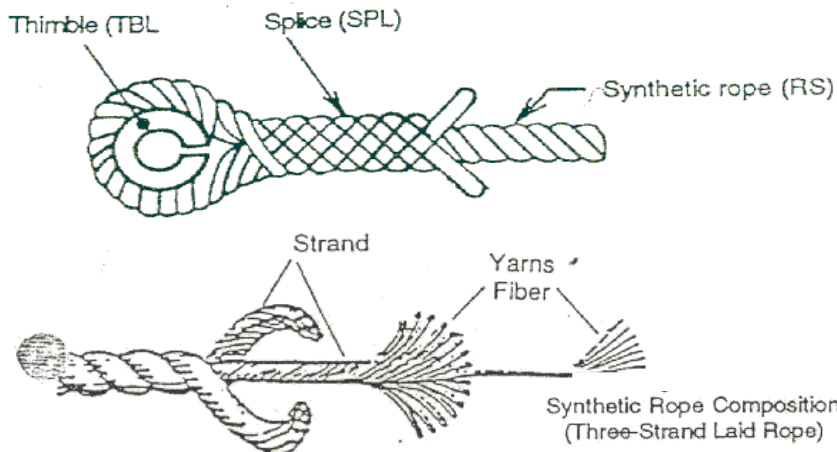

Item #	Description	Fail X	Pass ✓	Comments
	LANYARD			
	Rope Fibers			
	Rope Slices			
	Thimbles and Eyes			
	Rope Diameter			
	Labeling (tags)			
	Rope Hockling			
	SNAPHOOK			
	Hook Body			
	Hook Nose			
	Gate (keeper)			
	Lock			
	Eye			
	Hinge			
	Spring (inside gate)			

SYNTHETIC ROPE - LIFELINES - BRAIDED ROPES INSPECTION GUIDELINES

Braided Ropes

Grasp the rope with both hands and rotate the lifeline. Run your hands along the entire length of lifeline. Inspect strands from end to end.

Synthetic fiber ropes will show a reduction in strength when used at elevated temperatures. For exposure to excessive temperatures specific for the rope fiber refer to the rope manufacturer's specifications and instructions.

Damage and deterioration may not show up through a sight (visual) inspection only – manual (touch) the lanyard is equally important.

Rope Diameter

Weakened areas from extreme loads will appear as a noticeable change in original diameter. The rope diameter should be uniform throughout. If areas appear to be reduced more than 5% from original rope diameter, remove from service (ie: 5/8" rope, 5% reduction would be approx. 1/32" – calipers can be used to measure.)

Visual and Touch Inspection	✓ Pass ✗ Fail Criteria
✗ Check for pulled cover strands	More than 4 consecutive pulled cover strands (which cannot be reincorporated into cover braid) Remove from service
✗ Cover damage - core visible	
✗ Core damage - pulled, cut, abraded, powdered, or melted strands	
✗ Cover - cuts or nicks	
✗ Cover - broken fibers	
✗ Overall deterioration	
✗ Modifications by user	
✗ Fraying/Abrasions	
✗ Hard or shiny spots	Indicates heat damage
✗ Fused fibers or strands	Indicates heat damage
✗ Change in original diameter	Indicates possible fall
✗ Burnt, charred, or melted fibers	Indicates heat damage
✗✓ Material marked w/permanent marker	Check w/manufacturer
✗ Knots or kinks	
✗✓ Discoloration of rope and brittle fibers (such as splinters/slivers)	Dependant on cause of discoloration but may indicate chemical attack or UV degradation

SYNTHETIC ROPE - LIFELINES - BRAIDED ROPES INSPECTION GUIDELINES

Thimbles and Eyes

Thimbles (steel or plastic) must be seated firmly in the eye. Thimbles must not show any sign of damage. Check around the eye itself for damage, wear, or deterioration.

Visual and Touch Inspection

- ✓ Pass
- ✗ Fail Criteria

- ✗ Missing thimble(s)
- ✗ Loose thimble(s)
- ✗ Damaged thimbles - white stress marks, thimble collapsing over itself
- ✗ Damage to female side of eye (side in contact with thimble)
- ✗ Eye damage due to cuts, nicks, abrasions, fraying, fused areas
(look for same indicators as you would for the rope body itself)
- ✗ Eyes with metal thimbles – look for rust in or around the eye

Fittings

- ✗ Wear or cracks
- ✗ Corrosion or pitting
- ✗ Deformation/bends
- ✗ Mismatched parts or modifications
- ✗ Obvious damage

SYNTHETIC ROPE - LIFELINES - BRAIDED ROPES INSPECTION GUIDELINES

Snap Hooks

Snap hooks should be of the self-locking type. Snap hooks are generally proof tested to 3,600 lbs and have minimum tensile strength of 5,000 lbs.

Visual and Touch Inspection	✓ Pass ✗ Fail Criteria
-----------------------------	---------------------------

- ✗ Snap hooks should be of the self-locking type
- ✗ No hook or eye distortion (twists, bends, or elongation)
- ✗ Latch/keeper should seat into the nose w/o binding
- ✗ Latch/keeper should not be distorted or obstructed
- ✗ Overall deterioration/Excessive wear
- ✗ Modifications by the user
- ✗ No cracks
- ✗ No excessive wear
- ✗ Rust/pitting/corrosion
- ✗ No missing parts
- ✗ No rough or sharp edges

Snap Hook Locking Mechanism

- ✗ Disengage locking mechanism and open keeper (keeper should open freely)
- ✗ Disengage locking mechanism and release (locking mechanism should return to engaged position)

Snap Hook Keeper

- ✗ Check keeper spring action by opening the keeper and releasing (keeper should return to closed position without hanging up it should not close slowly)
- ✗ Push on keeper without engaging locking mechanism (keeper should not open)
- ✗ Check to see the keeper is seated firmly on the snap hook nose – there should be no side play (lateral movement)

Tagging System

Date of manufacture and length of lifeline can be found on one of the metal ferrules.

- ✗ Check tag for date of manufacture and remove from service if past adopted service life policy
- ✗ If tagging system is missing or not legible remove lanyard from service

INSPECTION CHECKLIST - FALL PROTECTION EQUIPMENT

Description:	Model #:
Serial #:	Date of Manufacture:
Inspector:	Date Inspected:
Inspector Signature:	

X FAIL: Initial _____
REMOVE FROM SERVICE

✓ PASS: Initial _____
RETURN TO SERVICE

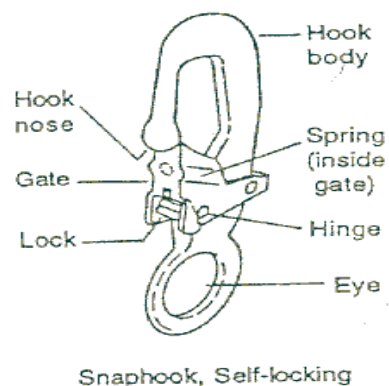

Item #	Description	Fail X	Pass ✓	Comments
	Rope Fibers			
	Cover Damage			
	Thimbles and Eyes			
	Fittings			
	Labeling (tags)			
	Discoloration			
	SNAPHOOK			
	Hook Body			
	Hook Nose			
	Gate (keeper)			
	Lock			
	Eye			
	Hinge			
	Spring (inside gate)			

SYNTHETIC ROPE - LIFELINES - KERNMANTLE ROPES INSPECTION GUIDELINES

Kernmantle Ropes

Grasp the rope with both hands and rotate the lifeline. Run your hands along the entire length of lifeline. Inspect strands from end to end.

Synthetic fiber ropes will show a reduction in strength when used at elevated temperatures. For exposure to excessive temperatures specific for the rope fiber refer to the rope manufacturer's specifications and instructions.

Damage and deterioration may not show up through a sight (visual) inspection only – manual (touch) the lanyard is equally important.

Rope Diameter

Weakened areas from extreme loads will appear as a noticeable change in original diameter. The rope diameter should be uniform throughout. If areas appear to be reduced more than 5% from original rope diameter, remove from service (ie: 5/8" rope, 5% reduction would be approx. 1/32" – calipers can be used to measure.)

Visual and Touch Inspection

- ✓ Pass
- ✗ Fail Criteria

- ✗ Extremely fuzzy cover
- ✗ Check for bulges/lumps & flat spots
- ✗ Cover damage - core visible
- ✗ Check for indication of inner core damage - rope will have an hourglass shape
- ✗ Core damage - pulled, cut, abraded, powdered, or melted strands
- ✗ Cover - cuts or nicks
- ✗ Cover - broken fibers
- ✗ Overall deterioration
- ✗ Modifications by user
- ✗ Fraying/Abrasions
- ✗ Compacted or hard/shiny spots
- ✗ Fused fibers or strands Indicates heat damage
- ✗ Change in original diameter Indicates possible fall
- ✗ Burnt, charred, or melted fibers Indicates heat damage
- ✗✓ Material marked w/permanent marker Check w/manufacturer
- ✗ Knots or kinks
- ✗✓ Discoloration of rope and brittle fibers Dependant on cause of discoloration
(such as splinters/slivers) but may indicate chemical attack
or UV degradation

SYNTHETIC ROPE - LIFELINES - KERNMANTLE ROPES INSPECTION GUIDELINES

Thimbles and Eyes

Thimbles (steel or plastic) must be seated firmly in the eye. Thimbles must not show any sign of damage. Check around the eye itself for damage, wear or deterioration.

Visual and Touch Inspection

- ✓ Pass
- ✗ Fail Criteria

- ✗ Missing thimble(s)
- ✗ Loose thimble(s)
- ✗ Damaged thimbles
- ✗ Damage to female side of eye (side in contact with thimble)
- ✗ Eye damage due to cuts, nicks, abrasions, fraying, fused areas
(look for same indicators as you would for the rope body itself)
- ✗ Eyes with metal thimbles – look for rust in or around the eye

Fittings

- ✗ Wear or cracks
- ✗ Corrosion or pitting
- ✗ Deformation/bends
- ✗ Mismatched parts or modifications
- ✗ Obvious damage

SYNTHETIC ROPE - LIFELINES - KERNMANTLE ROPES INSPECTION GUIDELINES

Snap Hooks

Snap hooks should be of the self-locking type. Snap hooks are generally proof tested to 3,600 lbs and have minimum tensile strength of 5,000 lbs.

Visual and Touch Inspection

- ✓ Pass
- ✗ Fail Criteria

- ✗ Snap hooks should be of the self-locking type
- ✗ No hook or eye distortion (twists, bends, or elongation)
- ✗ Latch/keeper should seat into the nose w/o binding
- ✗ Latch/keeper should not be distorted or obstructed
- ✗ Overall deterioration/Excessive wear
- ✗ Modifications by the user
- ✗ No cracks
- ✗ No excessive wear
- ✗ Rust/pitting/corrosion
- ✗ No missing parts
- ✗ No rough or sharp edges

Snap Hook Locking Mechanism

- ✗ Disengage locking mechanism and open keeper (keeper should open freely)
- ✗ Disengage locking mechanism and release (locking mechanism should return to engaged position)

Snap Hook Keeper

- ✗ Check keeper spring action by opening the keeper and releasing (keeper should return to closed position without hanging up it should not close slowly)
- ✗ Push on keeper without engaging locking mechanism (keeper should not open)
- ✗ Check to see the keeper is seated firmly on the snap hook nose – there should be no side play (lateral movement)

Tagging System

Date of manufacturer can be found on one of the metal ferrules.

- ✗ Check tag for date of manufacture and remove from service if past adopted service life policy
- ✗ If tagging system is missing or not legible remove lanyard from service

INSPECTION CHECKLIST - FALL PROTECTION EQUIPMENT

Description:	Model #:
Serial #:	Date of Manufacture:
Inspector:	Date Inspected:
Inspector Signature:	

X FAIL: Initial _____
REMOVE FROM SERVICE

✓ PASS: Initial _____
RETURN TO SERVICE

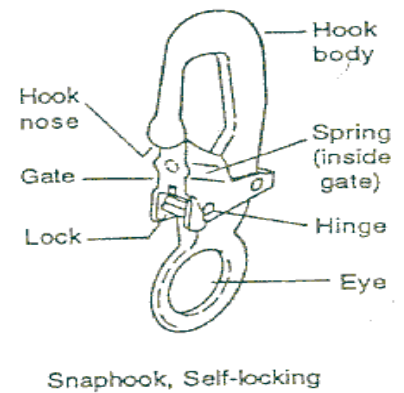
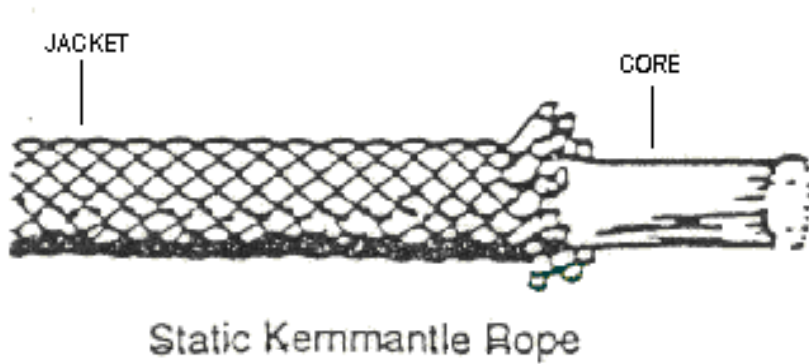

Item #	Description	Fail X	Pass ✓	Comments
	Rope Diameter			
	Cover Damage			
	Thimbles and Eyes			
	Fittings			
	Labeling (tags)			
	Discoloration			
	SNAPHOOK			
	Hook Body			
	Hook Nose			
	Gate (keeper)			
	Lock			
	Eye			
	Hinge			
	Spring (inside gate)			

SYNTHETIC ROPE - LIFELINES - POLYSTEEL INSPECTION GUIDELINES

Polysteel

Grasp the rope with both hands and rotate the lifeline. Run your hands along the entire length of lifeline. Inspect strands from end to end.

Synthetic fiber ropes will show a reduction in strength when used at elevated temperatures. For exposure to excessive temperatures specific for the rope fiber refer to the rope manufacturer's specifications and instructions.

Damage and deterioration may not show up through a sight (visual) inspection only – manual (touch) the lanyard is equally important.

Rope Diameter

Weakened areas from extreme loads will appear as a noticeable change in original diameter. The rope diameter should be uniform throughout. If areas appear to be reduced more than 5% from original rope diameter, remove from service (ie: 5/8" rope, 5% reduction would be approx. 1/32" – calipers can be used to measure.)

Visual and Touch Inspection	<ul style="list-style-type: none"> ✓ Pass ✗ Fail Criteria
-----------------------------	---

✗ Fiber cuts or nicks	
✗ Broken fibers	
✗ Fuzzy or worn fibers	
✗ Overall deterioration	
✗ Modifications by user	
✗ Fraying/Abrasions	
✗ Hard or shiny spots	Indicates heat damage
✗ Fused fibers or strands	Indicates heat damage
✗ Change in original diameter	Indicates possible fall
✗ Burnt, charred, or melted fibers	Indicates heat damage
✗✓ Material marked w/permanent marker	Check w/manufacturer
✗ Kinks, hockling,* or knots	
✗✓ Discoloration of rope and brittle fibers (such as splinters/slivers)	Dependant on cause of discoloration but may indicate chemical attack or UV degradation

* **HOCKLING** – unraveling of the lanyard due to constant turning in the same direction or shock loading

SYNTHETIC ROPE - LIFELINES - POLYSTEEL INSPECTION GUIDELINES

Thimbles and Eyes

Thimbles (steel or plastic) must be seated firmly in the eye. Thimbles must not show any sign of damage. Check around the eye itself for damage, wear or deterioration.

Visual and Touch Inspection

- ✓ Pass
- ✗ Fail Criteria

- ✗ Missing thimble(s)
- ✗ Loose thimble(s)
- ✗ Damaged thimbles - white stress marks, thimble collapsing over itself
- ✗ Damage to female side of eye (side in contact with thimble)
- ✗ Eye damage due to cuts, nicks, abrasions, fraying, fused areas
(look for same indicators as you would for the rope body itself)
- ✗ Eyes with metal thimbles – look for rust in or around the eye

Rope Splices

In the construction of the lifeline the rope is spliced around a plastic or metal thimble. Eye splices in twisted rope having three or more strands shall have a minimum of four tucks (ANSI Z359.1-1992.) (CSA-Z259.1-95 requires a minimum of five full tucks.) Both standards require the ends secured to prevent unraveling.

- ✗ Splices not secured properly from unraveling – look for tape, shrink wrap tube, stiffening agent (most common methods used by manufacturers)
- ✗ Splices starting to unravel
- ✗ Splices showing damage or deterioration (look for same indicators as you would for the rope itself)

SYNTHETIC ROPE - LIFELINES - POLYSTEEL INSPECTION GUIDELINES

Snap Hooks

Snap hooks should be of the self-locking type. Snap hooks are generally proof tested to 3,600 lbs and have minimum tensile strength of 5,000 lbs.

Visual and Touch Inspection	✓ Pass ✗ Fail Criteria
-----------------------------	---------------------------

- ✗ Snap hooks should be of the self-locking type
- ✗ No hook or eye distortion (twists, bends, or elongation)
- ✗ Latch/keeper should seat into the nose w/o binding
- ✗ Latch/keeper should not be distorted or obstructed
- ✗ Overall deterioration/Excessive wear
- ✗ Modifications by the user
- ✗ No cracks
- ✗ No excessive wear
- ✗ Rust/pitting/corrosion
- ✗ No missing parts
- ✗ No rough or sharp edges

Snap Hook Locking Mechanism

- ✗ Disengage locking mechanism and open keeper (keeper should open freely)
- ✗ Disengage locking mechanism and release (locking mechanism should return to engaged position)

Snap Hook Keeper

- ✗ Check keeper spring action by opening the keeper and releasing (keeper should return to closed position without hanging up it should not close slowly)
- ✗ Push on keeper without engaging locking mechanism (keeper should not open)
- ✗ Check to see the keeper is seated firmly on the snap hook nose – there should be no side play (lateral movement)

Tagging System

Lifelines must have a legible tag identifying the, model, date of manufacture, name of manufacturer, limitations, and warnings.

- ✗ Check tag for date of manufacture and remove from service if past adopted service life policy
- ✗ If tagging system is missing or not legible remove lanyard from service.

INSPECTION CHECKLIST - FALL PROTECTION EQUIPMENT

Description:	Model #:
Serial #:	Date of Manufacture:
Inspector:	Date Inspected:
Inspector Signature:	

X FAIL: Initial _____

✓ PASS: Initial _____

REMOVE FROM SERVICE

RETURN TO SERVICE

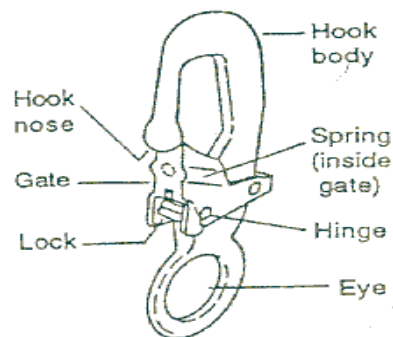
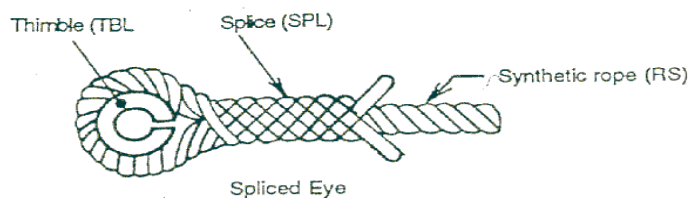
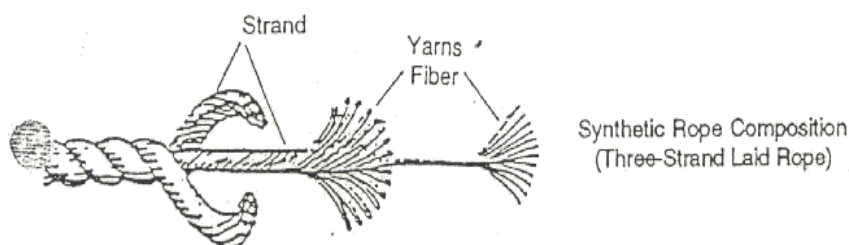

Item #	Description	Fail X	Pass ✓	Comments
	Rope Fibers			
	Rope Splices			
	Thimbles and Eyes			
	Rope Diameter			
	Labeling (tags)			
	Rope Hockling			
	SNAPHOOK			
	Hook Body			
	Hook Nose			
	Gate (keeper)			
	Lock			
	Eye			
	Hinge			
	Spring (inside gate)			

WIRE ROPE LIFELINES INSPECTION GUIDELINES

Wire Rope

Grasp the lifeline with your hands and rotate the lanyard, checking both sides. Watch for unusual wearing patterns on the wire. Broken strands or wires will separate from the body of the lanyard. **To avoid hand injury always wear protective gloves when inspecting a wire rope lanyard.**

Note: Unlike rigging inspection standards, wire rope used for the purpose of fall protection is not allowed any broken wires or strands.

Visual and Touch Inspection

- ✓ Pass
- ✗ Fail Criteria

- ✗ Cuts, frayed areas
- ✗ Worn or broken strands/wires
- ✗ Overall deterioration/Excessive outside wear
- ✗ Modifications by the user
- ✗ Rust/pitting/corrosion
- ✗ Crushed/jammed or flattened strands
- ✗ Bulges in rope
- ✗ Gaps between strands
- ✗ Heat damage, torch burns, or electric arc strikes
- ✗ Kinks, bird-caging
- ✗ Core protrusion
- ✗ Do not use frozen rope

Fittings

- ✗ Wear or cracks
- ✗ Corrosion or pitting
- ✗ Deformation/bends
- ✗ Mismatched parts or modifications
- ✗ Obvious damage

Splices

- ✗ Worn or broken wires
- ✗ Crushed/jammed or flattened strands
- ✗ Corrosion

WIRE ROPE LIFELINES INSPECTION GUIDELINES

Snap Hooks

Snap hooks should be of the self-locking type. Snap hooks are generally proof tested to 3,600 lbs and have minimum tensile strength of 5,000 lbs.

Visual and Touch Inspection

- ✓ Pass
- ✗ Fail Criteria

- ✗ Snap hooks should be of the self-locking type
- ✗ No hook or eye distortion (twists, bends, or elongation)
- ✗ Latch/keeper should seat into the nose w/o binding
- ✗ Latch/keeper should not be distorted or obstructed
- ✗ Overall deterioration/Excessive wear
- ✗ Modifications by the user
- ✗ No cracks
- ✗ No excessive wear
- ✗ Rust/pitting/corrosion
- ✗ No missing parts
- ✗ No rough or sharp edges

Snap Hook Locking Mechanism

- ✗ Disengage locking mechanism and open keeper (keeper should open freely)
- ✗ Disengage locking mechanism and release (locking mechanism should return to engaged position)

Snap Hook Keeper

- ✗ Check keeper spring action by opening the keeper and releasing (keeper should return to closed position without hanging up it should not close slowly)
- ✗ Push on keeper without engaging locking mechanism (keeper should not open)
- ✗ Check to see the keeper is seated firmly on the snap hook nose – there should be no side play (lateral movement)

INSPECTION CHECKLIST - FALL PROTECTION EQUIPMENT

Description:	Model #:
Serial #:	Date of Manufacture:
Inspector:	Date Inspected:
Inspector Signature:	

X FAIL: Initial _____
REMOVE FROM SERVICE

✓ PASS: Initial _____
RETURN TO SERVICE

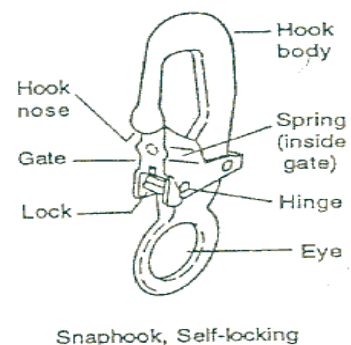
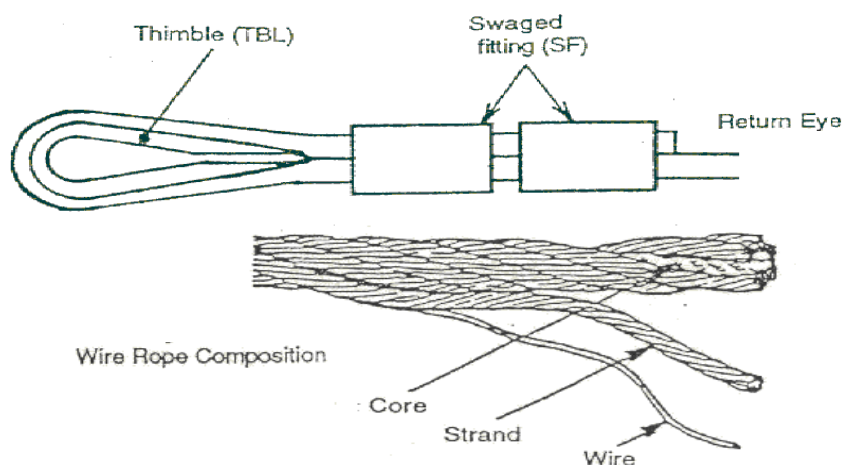

Item #	Description	Fail X	Pass ✓	Comments
	WIRE ROPE			
	Broken Wires			
	Rust/Corrosion/Pitting			
	Deformations			
	Heat Damage			
	Fittings/Thimbles			
	Splices			
	Labeling (tags)			
	SNAPHOOK			
	Hook Body			
	Hook Nose			
	Gate (keeper)			
	Lock			
	Eye			
	Hinge			
	Spring (inside gate)			

RETRACTABLE LANYARD (HOUSING/COVER FIELD REMOVABLE) INSPECTION GUIDELINES

Self Retracting Lanyard - Complete w/Webbing Lifeline

This type of SRL is usually 8' to 10' in length and the housing/cover is not permanently affixed to the unit.

When inspecting a self retracting lanyard, be sure to pull out all the lifeline material. Lifeline material must be inspected end to end.

Test methods employed will be:

- 1) Lanyard Retraction & Tension Test: tests the lifelines tension & ability to retract
- 2) Braking Test: tests the braking mechanism is working and engaging.

Visual and Touch Inspection	✓ Pass ✗ Fail Criteria
-----------------------------	---------------------------

- ✗ Check load impact indicator* for activation (if retractable is equipped with one)
- ✗ Loose fasteners
- ✗ Physical damage or missing parts
- ✗ Cracks or wear
- ✗ Check all connecting areas - no deformations allowed
- ✗ Corrosion
- ✗ Overall deterioration
- ✗ Modifications by user
- ✗ Bent, cracked, distorted, worn, or malfunctioning parts
- ✗ Inspect lifeline for cuts, burns, corrosion, kinks, frays, or worn areas
- ✗ Inspect lifeline sewing for loose, broken, or damaged stitches
- ✗ Inspect lifeline for discoloration, brittleness, melted fibers, shiny/hard spots
- ✗ Inspect housing inside and out for deformations, cracks, physical damage
- ✗✓ Check for paint, dirt, grease or other materials (contaminants)
Remove contaminants as per manufacturer's instructions

Note: The load impact indicator* can be a fold sewn into the webbing lifeline above the snap hook A warning flag is included and will be exposed should the lifeline be subjected to fall arresting forces.

Material required to conduct tests

- 1) Anchor point (ie: tripod or similar device)
- 2) Self Retracting Lifeline

RETRACTABLE LANYARD (HOUSING/COVER FIELD REMOVABLE) INSPECTION GUIDELINES

Lanyard Retraction & Tension Test

The purpose of the lanyard retraction & tension test is to ensure the lifeline is retracting smoothly into and out of the housing.

Steps

- 1) Mount self retracting lanyard on anchorage point
- 2) Pull out 50% of the lifeline length
- 3) Maintain a light tension on the lifeline
- 4) Allow lifeline to retract back into housing
(Always maintain light tension when lifeline is retracting)

Note: If lifeline does not pull out smoothly or sticks when retracting, pull all of the lifeline out of the housing and allow it to retract slowly under tension. Then repeat the above test.

Result

The lifeline should pull out freely and retract all the way back into the unit. Remove from service if device does not pass this test.

Braking Test

The purpose of the braking test is to ensure that the retractable's braking mechanism is working and engaging.

Steps

- 1) Mount self retracting lanyard on anchorage point
- 2) Grasp lifeline and apply a sharp steady pull downward until brakes engage
- 3) Keep tension on lifeline until brakes are fully engaged
- 4) Release tension
- 5) Allow lifeline to retract into housing under light tension

Result

Brakes should engage. There should be no slippage of the lifeline while the brakes are engaged. Once tension is released, the brakes should disengage and the unit should return to retractable mode. Remove from service if device does not pass this test.

RETRACTABLE LANYARD (HOUSING/COVER FIELD REMOVABLE) INSPECTION GUIDELINES

Snap Hooks

Snap hooks should be of the self-locking type. Snap hooks are generally proof tested to 3,600 lbs and have minimum tensile strength of 5,000 lbs.

Visual and Touch Inspection

- ✓ Pass
- ✗ Fail Criteria

- ✗ Snap hooks should be of the self-locking type
- ✗ No hook or eye distortion (twists, bends, or elongation)
- ✗ Latch/keeper should seat into the nose w/o binding
- ✗ Latch/keeper should not be distorted or obstructed
- ✗ Overall deterioration/Excessive wear
- ✗ Modifications by the user
- ✗ Rust/pitting/corrosion
- ✗ No cracks
- ✗ No missing parts
- ✗ No excessive wear
- ✗ No rough or sharp edges

Snap Hook Locking Mechanism

- ✗ Disengage locking mechanism and open keeper (keeper should open freely)
- ✗ Disengage locking mechanism and release (locking mechanism should return to engaged position).

Snap Hook Keeper

- ✗ Check keeper spring action by opening the keeper and releasing (keeper should return to closed position without hanging up it should not close slowly)
- ✗ Push on keeper without engaging locking mechanism (keeper should not open)
- ✗ Check to see the keeper is seated firmly on the snap hook nose – there should be no side play (lateral movement)

Swivel Connectors

- ✗ Swivel connections must not be loose and be allowed to swivel freely as designed
- ✗ No physical damage, cracks, bends, deformations

Tagging System

Every retractable should have a identification system, with details such as model, date of manufacture, name of manufacturer, limitations, and warnings.

- ✗ Check tag for date of manufacture and remove from service if past adopted service life policy
- ✗ If tagging system is missing or not legible remove lanyard from service.

Cleaning and Storage

Periodically clean the exterior of the device and wipe the lifeline using a damp cloth and mild detergent. Towel dry.

Store in a clean dry location, free of exposure to fumes, heat, direct ultra violet light, sunlight, and corrosive elements.

The lifeline should be fully retracted into the unit when not in use. Failure to do so on some models may cause premature weakening of the mainspring resulting in a loss of lifeline retraction.

INSPECTION CHECKLIST - FALL PROTECTION EQUIPMENT

Description:	Model #:
Serial #:	Date of Manufacture:
Inspector:	Date Inspected:
Inspector Signature:	

X FAIL: Initial _____
REMOVE FROM SERVICE

✓ PASS: Initial _____
RETURN TO SERVICE

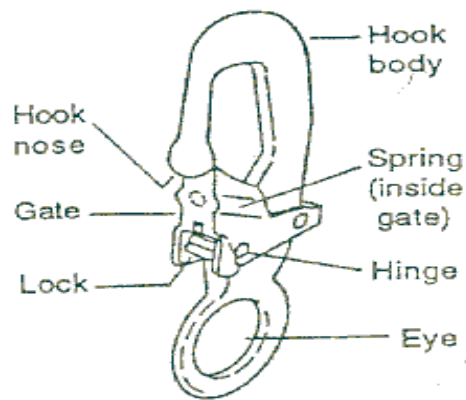
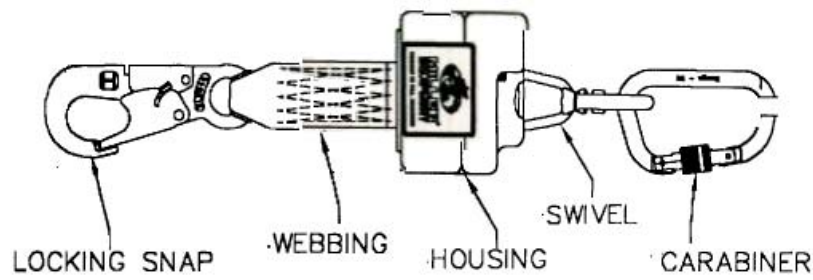

Snaphook, Self-locking

Item #	Description	Fail X	Pass ✓	Comments
	Load Impact Indicator			
	Webbing			
	Stitching			
	Labeling (tags)			
	Deformation			
	Housing			

Item #	Description	Fail X	Pass ✓	Comments
	SNAPHOOK			If applicable, see carabiners
	Swivel Connectors			
	Hook Body			
	Hook Nose			
	Gate (keeper)			
	Lock			
	Eye			
	Hinge			
	Spring (inside gate)			
	TESTS			
	Retraction and Tension			
	Braking Test			

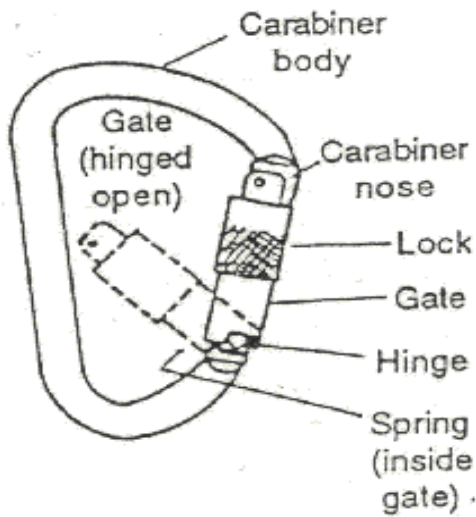

Carabiner, Self-locking

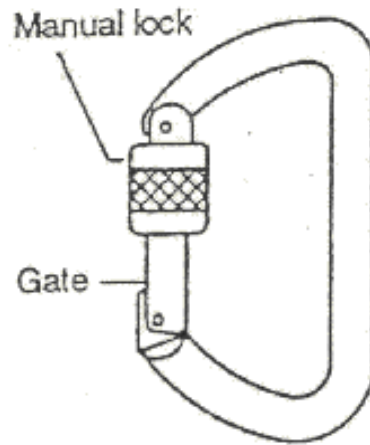

Carabiner Manual-locking

Item #	Description	Fail X	Pass ✓	Comments
	CARABINER			
	Carabiner Body			
	Carabiner Nose			
	Gate (hinged open)			
	Lock			
	Gate			
	Hinge			
	Spring (inside gate)			
	Manual Lock			

RETRACTABLE LANYARD (HOUSING/COVER NON FIELD REMOVABLE) INSPECTION GUIDELINES

Self Retracting Lanyard - Webbing or Wire Rope Lifeline

This type of SRL is usually 20' in length or greater. The housing/cover will be non field removable and will require special tools to open. Do not open unit unless you have been authorized and trained by the manufacturer.

Note: Manufacturers may require that the unit be sent in for an annual inspection – check owners manual for details.

When inspecting a self retracting lanyard be sure to pull out all the lifeline material. Lifeline material must be inspected end to end.

Test methods employed will be:

- 1) Lanyard Retraction & Tension Test: tests the lifelines tension & ability to retract
- 2) Braking Test: tests the braking mechanism is working and engaging.

Visual and Touch Inspection

- ✓ Pass
- ✗ Fail Criteria

Housing/Cover

- ✗ Ensure casing bolts are tight
- ✗ Loose fasteners
- ✗ Missing parts
- ✗ Cracks or wear
- ✗ Check all connecting areas - no deformations allowed
- ✗ Corrosion
- ✗ Overall deterioration
- ✗ Modifications by user
- ✗ Physical damage
- ✗ Bent, cracked, distorted, worn, or malfunctioning parts

Load Impact Indicator

- ✗ Check load impact indicator* for activation (if retractable is equipped with one)

Note: The load impact indicator* may be located in the lanyard above the snap hook. A label will be exposed when subjected to fall arresting forces. The load impact indicator may also be located on the snaphook or the unit itself. Check manufacturer's operation and installation instructions for exact location.

RETRACTABLE LANYARD (HOUSING/COVER NON FIELD REMOVABLE) INSPECTION GUIDELINES

Webbing

Grasp the webbing with your hands and bend the webbing, checking both sides.

This creates surface tension making damaged fibers or cuts easier to see. Webbing damage may not show up through a sight (visual) inspection only – manual (touch) inspection of the lanyard is equally important.

Visual and Touch Inspection

✓ Pass

✗ Fail Criteria

- | | |
|---------------------------------------|-------------------------------------|
| ✗ Cuts, nicks, or tears | |
| ✗ Broken fibers/cracks | |
| ✗ Overall deterioration | |
| ✗ Modifications by user | |
| ✗ Fraying/Abrasions | |
| ✗✓ Discoloration of material | Dependant on cause of discoloration |
| ✗ Hard or shiny spots | Indicates heat damage |
| ✗ Change in core size | Indicates possible fall |
| ✓ Mildew | Clean lanyard |
| ✗ Undue stitching | Indicates possible fall |
| ✗ Burnt, charred, or melted fibers | Indicates heat damage |
| ✗✓ Material marked w/permanent marker | Check w/manufacturer |
| ✗ Excessive hardness or brittleness | Indicates heat or UV damage |
| ✗ Knots in lanyard | |

RETRACTABLE LANYARD (HOUSING/COVER NON FIELD REMOVABLE) INSPECTION GUIDELINES

Wire Rope

Grasp the steel lanyard with your hands and rotate the lanyard, checking both sides. Watch for unusual wearing patterns on the wire. Broken strands or wires will separate from the body of the lanyard. To avoid hand injury always wear protective gloves when inspecting a wire rope lanyard.

Note: Unlike rigging inspection standards, wire rope used for the purpose of fall protection is not allowed any broken wires or strands.

Visual and Touch Inspection

- ✓ Pass
- ✗ Fail Criteria

- ✗ Cuts, frayed areas
- ✗ Worn or broken strands/wires
- ✗ Overall deterioration/Excessive outside wear
- ✗ Modifications by user
- ✗ Rust/pitting/corrosion
- ✗ Crushed/jammed or flattened strands
- ✗ Bulges in rope
- ✗ Gaps between strands
- ✗ Heat damage, torch burns, or electric arc strikes
- ✗ Kinks, bird-caging
- ✗ Core protrusion
- ✗ Do not use frozen rope

Fittings

- ✗ Wear or cracks
- ✗ Corrosion or pitting
- ✗ Deformation/bends
- ✗ Mismatched parts or modifications
- ✗ Obvious damage

Splices

- ✗ Worn or broken wires
- ✗ Crushed/jammed or flattened strands
- ✗ Corrosion

Material required to conduct tests

- 1) Anchor point (ie: tripod or similar device)
- 2) Self Retracting Lifeline

RETRACTABLE LANYARD (HOUSING/COVER NON FIELD REMOVABLE) INSPECTION GUIDELINES

Lanyard Retraction & Tension Test

Do not pull lifeline out of the housing or let it retract while the unit is laying flat. Always inspect and operate the unit in a mounted position.

The purpose of the lanyard retraction & tension test is to ensure the lifeline is retracting smoothly into and out of the housing.

Steps

- 1) Mount self retracting lanyard on anchorage point
- 2) Pull out 50% of the lifeline length
- 3) Maintain a light tension on the lifeline, approx. 0.45 kg (1 lb)
- 4) Allow lifeline to retract back into housing
(Always maintain light tension when lifeline is retracting)
- 5) Repeat Steps 2 to 4 this time pulling out 100% of lifeline length

Do Not allow lifeline to retract into housing uncontrolled – this could result in injury and damage to the unit.

Note: If lifeline does not pull out smoothly or sticks when retracting, pull the entire lifeline out of the housing and allow it to retract slowly under tension. Then repeat the above test.

Result

The lifeline should pull out freely and retract all the way back into the unit. Remove from service if device does not pass this test.

Braking Test

The purpose of the braking test is to ensure that the retractable's braking mechanism is working and engaging.

Steps

- 1) Mount retractable on anchorage point
- 2) Grasp lifeline and apply a sharp steady pull downward until brakes engage
- 3) Keep tension on lifeline until brakes are fully engaged
- 4) Release tension
- 5) Allow lifeline to retract into housing under light tension

Result

Brakes should engage. There should be no slippage of the lifeline while the brakes are engaged. Once tension is released, the brakes should disengage and the unit should return to retractable mode. Remove from service if device does not pass this test.

RETRACTABLE LANYARD (HOUSING/COVER NON FIELD REMOVABLE) INSPECTION GUIDELINES

Snap Hooks

Snap hooks should be of the self-locking type. Snap hooks are generally proof tested to 3,600 lbs and have minimum tensile strength of 5,000 lbs.

Visual and Touch Inspection

- ✓ Pass
- ✗ Fail Criteria

- ✗ Snap hooks should be of the self-locking type
- ✗ No hook or eye distortion (twists, bends, or elongation)
- ✗ Latch/keeper should seat into the nose w/o binding
- ✗ Latch/keeper should not be distorted or obstructed
- ✗ Overall deterioration/Excessive wear
- ✗ Modifications by the user
- ✗ Rust/pitting/corrosion
- ✗ No cracks
- ✗ No missing parts
- ✗ No excessive wear
- ✗ No rough or sharp edges

Snap Hook Locking Mechanism

- ✗ Disengage locking mechanism and open keeper (keeper should open freely)
- ✗ Disengage locking mechanism and release (locking mechanism should return to engaged position)

Snap Hook Keeper

- ✗ Check keeper spring action by opening the keeper and releasing (keeper should return to closed position without hanging up it should not close slowly)
- ✗ Push on keeper without engaging locking mechanism (keeper should not open)
- ✗ Check to see the keeper is seated firmly on the snap hook nose – there should be no side play (lateral movement)

Swivel Connectors

- ✗ Swivel connections must not be loose and be allowed to swivel freely as designed
- ✗ No physical damage, cracks, bends, deformations

Tagging System

Every retractable should have an identification system, with details such as model, date of manufacture, name of manufacturer, limitations, and warnings.

- ✗ Check tag for date of manufacture and remove from service if past adopted service life policy
- ✗ If tagging system is missing or not legible remove lanyard from service

Cleaning and Storage

Periodically clean the exterior of the device and wipe the lifeline using a damp cloth and mild detergent. Towel dry.

Store in a clean dry location, free of exposure to fumes, heat, direct ultra violet light, sunlight, and corrosive elements.

The lifeline should be fully retracted into the unit when not in use. Failure to do so on some models may cause premature weakening of the mainspring resulting in a loss of lifeline retraction.

INSPECTION CHECKLIST - FALL PROTECTION EQUIPMENT

Description:	Model #:
Serial #:	Date of Manufacture:
Inspector:	Date Inspected:
Inspector Signature:	

X FAIL: Initial _____ **REMOVE FROM SERVICE**
✓ PASS: Initial _____ **RETURN TO SERVICE**

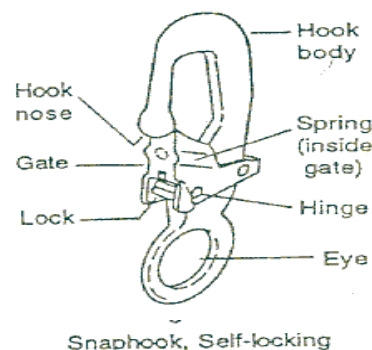
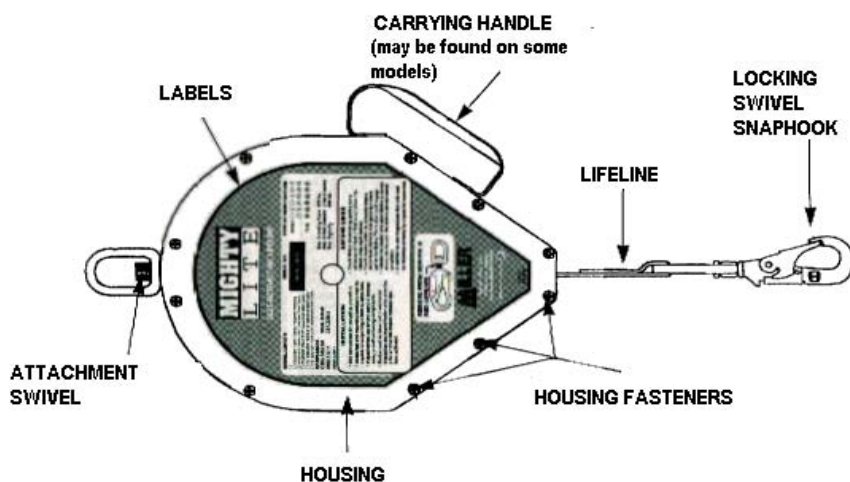

Item #	Description	Fail X	Pass ✓	Comments
	GENERAL			
	Load Impact Indicator			
	Housing Cover			
	Deformation			
	Labeling (tags)			
	SNAPHOOK			If applicable, see carabiners
	Swivel Connectors			
	Hook Body			
	Hook Nose			
	Gate (keeper)			
	Lock			
	Eye			
	Hinge			
	Spring (inside gate)			

Item #	Description	Fail X	Pass ✓	Comments
	LIFELINE - WEB			
	Webbing			
	Stitching			
	LIFELINE - WIRE ROPE			
	Broken Wires			
	Rust/Corrosion/Pitting			
	Deformations			
	Heat Damage			
	Fittings/Thimbles			
	Splices			
	TESTS			
	Retraction and Tension			
	Braking Test			

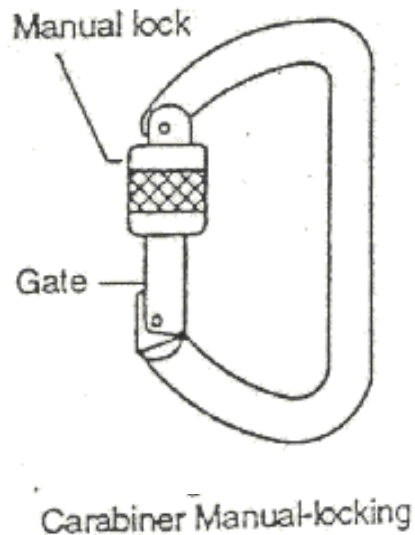
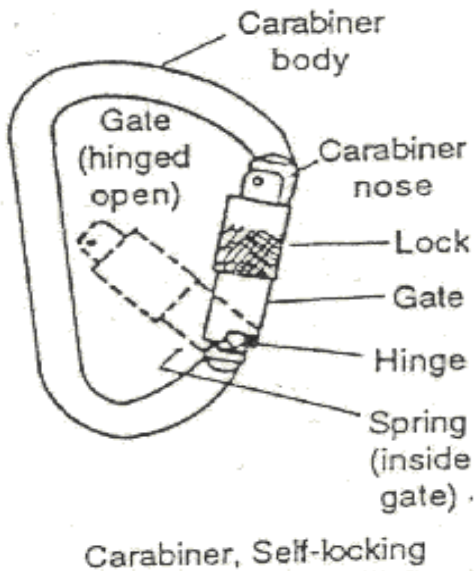

Item #	Description	Fail X	Pass ✓	Comments
	CARABINER			
	Carabiner Body			
	Carabiner Nose			
	Gate (hinged open)			
	Lock			
	Gate			
	Hinge			
	Spring (inside gate)			
	Manual Lock			

SELF RETRACTING LIFELINE COMPLETE W/RECOVERY INSPECTION GUIDELINES

Self Retracting Lifeline Complete w/ Recovery

This type of SRL will have the ability of retrieval via a winching mechanism. The housing/cover will be non-field removable and require special tools to open. Do not open unit unless you have been authorized and trained by the manufacturer.

Note: Manufacturers may require that the unit be sent in for an annual inspection – check owners manual for details.

When inspecting a self retracting lanyard be sure to pull out all the lifeline material. Lifeline material must be inspected end to end.

Test methods employed will be:

- 1) Lanyard Retraction & Tension Test: tests the lifelines tension & ability to retract
- 2) Braking Test: tests the braking mechanism is working and engaging
- 3) Retrieval Mode: tests the units retrieval mechanism

Visual and Touch Inspection

- ✓ Pass
- ✗ Fail Criteria

Housing/Cover

- ✗ Ensure casing bolts are tight
- ✗ Loose fasteners
- ✗ Missing parts
- ✗ Cracks or wear
- ✗ Check all connecting areas - no deformations allowed
- ✗ Corrosion
- ✗ Overall deterioration
- ✗ Modifications by user
- ✗ Physical damage
- ✗ Bent, cracked, distorted, worn, or malfunctioning parts

Load Impact Indicator

- ✗ Check load impact indicator* for activation (if retractable is equipped with one)

Note: The load impact indicator* may be located in the lanyard above the snap hook. A label will be exposed when subjected to fall arresting forces. The load impact indicator may also be located on the snaphook or the unit itself. Check manufacturer's operation and installation instructions for exact location.

SELF RETRACTING LIFELINE COMPLETE W/RECOVERY INSPECTION GUIDELINES

Wire Rope

Grasp the steel lanyard with your hands and rotate the lanyard, checking both sides. Watch for unusual wearing patterns on the wire. Broken strands or wires will separate from the body of the lanyard. To avoid hand injury always wear protective gloves when inspecting a wire rope lanyard.

Note: Unlike rigging inspection standards, wire rope used for the purpose of fall protection is not allowed any broken wires or strands.

Visual and Touch Inspection

- ✓ Pass
- ✗ Fail Criteria

- ✗ Cuts, frayed areas
- ✗ Worn or broken strands/wires
- ✗ Overall deterioration/Excessive outside wear
- ✗ Modifications by user
- ✗ Rust/pitting/corrosion
- ✗ Crushed/jammed or flattened strands
- ✗ Bulges in rope
- ✗ Gaps between strands
- ✗ Heat damage, torch burns or electric arc strikes
- ✗ Kinks, bird-caging
- ✗ Core protrusion
- ✗ Do not use frozen rope

Fittings

- ✗ Wear or cracks
- ✗ Corrosion or pitting
- ✗ Deformation/bends
- ✗ Mismatched parts or modifications
- ✗ Obvious damage

Splices

- ✗ Worn or broken wires
- ✗ Crushed/jammed or flattened strands
- ✗ Corrosion

Material required to conduct tests

- 1) Anchor point (ie: tripod or similar device)
- 2) Self Retracting Lifeline

SELF RETRACTING LIFELINE COMPLETE W/RECOVERY INSPECTION GUIDELINES

Lanyard Retraction & Tension Test

**Do not pull lifeline out of the housing or let it retract while the unit is laying flat.
Always inspect and operate the unit in a mounted position.**

The purpose of the lanyard retraction & tension test is to ensure the lifeline is retracting smoothly into and out of the housing.

Steps

- 1) Mount self retracting lanyard on anchorage point
- 2) Pull out 50% of the lifeline length
- 3) Maintain a light tension on the lifeline, approx. 0.45 kg (1 lb)
- 4) Allow lifeline to retract back into housing
(Always maintain light tension when lifeline is retracting)
- 5) Repeat Steps 2 to 4 this time pulling out 100% of lifeline length

Do Not allow lifeline to retract into housing uncontrolled – this could result in injury and damage to the unit.

Note: If lifeline does not pull out smoothly or sticks when retracting, pull the entire lifeline out of the housing and allow it to retract slowly under tension. Then repeat the above test.

Result

The lifeline should pull out freely and retract all the way back into the unit. Remove from service if device does not pass this test.

Braking Test

The purpose of the braking test is to ensure that the retractable's braking mechanism is working and engaging.

Steps

- 1) Mount retractable on anchorage point
- 2) Grasp lifeline and apply a sharp steady pull downward until brakes engage
- 3) Keep tension on lifeline until brakes are fully engaged
- 4) Release tension
- 5) Allow lifeline to retract into housing under light tension

Result

Brakes should engage. There should be no slippage of the lifeline while the brakes are engaged. Once tension is released, the brakes should disengage and the unit should return to retractable mode. Remove from service if device does not pass this test.

SELF RETRACTING LIFELINE COMPLETE W/RECOVERY INSPECTION GUIDELINES

Retrieval Mode Test

The purpose of the retrieval mode test is to ensure that the retractable's retrieval mechanism is working and engaging.

Note: some units when in the lowering position will require a minimum of 75 lbs

Steps

- 1) Mount self retracting lanyard on anchorage point
- 2) Grasp lifeline & pull out several feet of lifeline
- 3) Hold line in position, maintaining light tension on the line
- 4) Without engaging retrieval mode attempt to retrieve line
Result - line should not retrieve unless unit has been activated
- 5) Now engage retrieval mode
- 6) Keeping light tension on the line – use the winch handle to retrieve the line into the device

Result

Brakes should engage. There should be no slippage of the lifeline while the brakes are engaged. Once tension is released, the brakes should disengage and the unit should return to retractable mode. Remove from service if device does not pass this test.

SELF RETRACTING LIFELINE COMPLETE W/RECOVERY INSPECTION GUIDELINES

Snap Hooks

Snap hooks should be of the self-locking type. Snap hooks are generally proof tested to 3,600 lbs and have minimum tensile strength of 5,000 lbs.

Visual and Touch Inspection	✓ Pass ✗ Fail Criteria
-----------------------------	---------------------------

- ✗ Snap hooks should be of the self-locking type
- ✗ No hook or eye distortion (twists, bends, or elongation)
- ✗ Latch/keeper should seat into the nose w/o binding
- ✗ Latch/keeper should not be distorted or obstructed
- ✗ Overall deterioration/Excessive wear
- ✗ Modifications by the user
- ✗ Rust/pitting/corrosion
- ✗ No cracks
- ✗ No missing parts
- ✗ No excessive wear
- ✗ No rough or sharp edges

Snap Hook Locking Mechanism

- ✗ Disengage locking mechanism and open keeper (keeper should open freely)
- ✗ Disengage locking mechanism and release (locking mechanism should return to engaged position).

Snap Hook Keeper

- ✗ Check keeper spring action by opening the keeper and releasing (keeper should return to closed position without hanging up it should not close slowly)
- ✗ Push on keeper without engaging locking mechanism (keeper should not open)
- ✗ Check to see the keeper is seated firmly on the snap hook nose – there should be no side play (lateral movement)

Swivel Connectors

- ✗ Swivel connections must not be loose and be allowed to swivel freely as designed
- ✗ No physical damage, cracks, bends, deformations

Tagging System

Every retractable should have an identification system, with details such as model, date of manufacture, name of manufacturer, limitations, and warnings.

- ✗ Check tag for date of manufacture and remove from service if past adopted service life policy
- ✗ If tagging system is missing or not legible remove lanyard from service

Cleaning and Storage

Periodically clean the exterior of the device and wipe the lifeline using a damp cloth and mild detergent. Towel dry.

Store in a clean dry location, free of exposure to fumes, heat, direct ultra violet light, sunlight, and corrosive elements.

The lifeline should be fully retracted into the unit when not in use. Failure to do so on some models may cause premature weakening of the mainspring resulting in a loss of lifeline retraction.

INSPECTION CHECKLIST - FALL PROTECTION EQUIPMENT

Description:	Model #:
Serial #:	Date of Manufacture:
Inspector:	Date Inspected:
Inspector Signature:	

X FAIL: Initial _____
REMOVE FROM SERVICE

✓ PASS: Initial _____
RETURN TO SERVICE

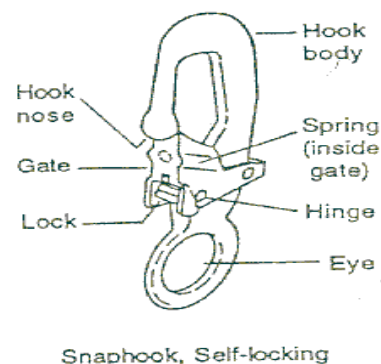
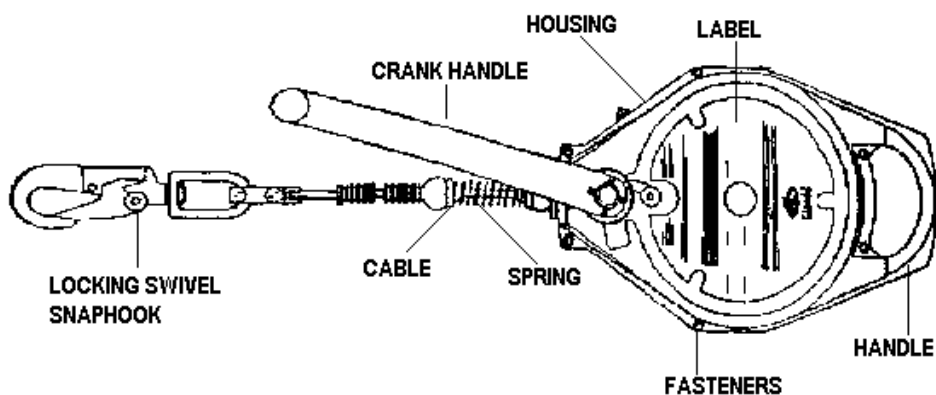

Item #	Description	Fail X	Pass ✓	Comments
	GENERAL			
	Load Impact Indicator			
	Housing Cover			
	Deformation			
	Labeling (tags)			
	SNAPHOOK			If applicable, see carabiners
	Swivel Connectors			
	Hook Body			
	Hook Nose			
	Gate (keeper)			
	Lock			
	Eye			
	Hinge			
	Spring (inside gate)			

Item #	Description	Fail X	Pass ✓	Comments
	LIFELINE - WEB			
	Webbing			
	Stitching			
	LIFELINE - WIRE ROPE			
	Broken Wires			
	Rust/Corrosion/Pitting			
	Deformations			
	Heat Damage			
	Fittings/Thimbles			
	Splices			
	TESTS			
	Retraction and Tension			
	Braking Test			
	Retrieval Mode Test			

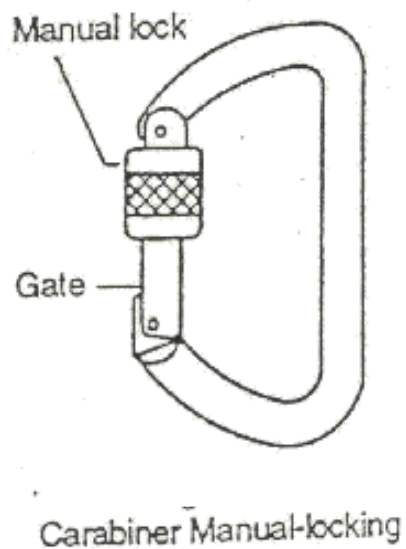
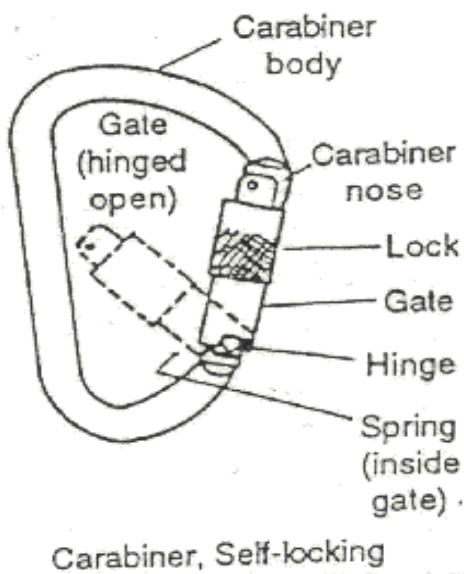

Item #	Description	Fail X	Pass ✓	Comments
	CARABINER			
	Carabiner Body			
	Carabiner Nose			
	Gate (hinged open)			
	Lock			
	Gate			
	Hinge			
	Spring (inside gate)			
	Manual Lock			

Honeywell Safety Products

300 South Tryon Street
Charlotte, NC 28202
Tel: 800-430-5490
Fax: 800-322-1330
safety.honeywell.com

Product Inspection Guide | Rev A | 10/19
© 2019 Honeywell International Inc.

**THE
FUTURE
IS
WHAT
WE
MAKE IT**

Honeywell